

ARC-1732

17" 6th Gen Intel® Core™ BGA Processor i7/i5/i3 Fanless
Rugged Touch Panel PC with IET Expansion

Quick Reference Guide

2nd Ed – 26 August 2020

Copyright Notice

Copyright © 2020 Avalue Technology Inc., ALL RIGHTS RESERVED.

Content

1.	Getting Started	6
1.1	Safety Precautions.....	6
1.2	Packing List	6
1.3	System Specifications.....	7
1.4	System Overview.....	11
1.4.1	I/O View	11
1.5	System Dimensions	12
2.	Hardware Configuration	13
2.1	ARC-1732 connector mapping	14
2.1.1	Serial port 1 connector (COM1).....	14
2.1.2	Serial port 2 connector (COM2).....	14
2.2	Installing Hard Disk & Memory	15
2.3	Installing ARC-BYT DB.....	17
2.4	ARC-SKLU Overviews.....	19
2.5	ARC-SKLU Jumper and Connector list	20
2.6	ARC-SKLU Jumpers & Connectors settings	21
2.6.1	Clear CMOS (JCOMS1)	21
2.6.2	Serial port 1/2 pin9 signal select (JRI1/JRI2)	21
2.6.3	LCD backlight brightness adjustment (JBKLSEL1)	22
2.6.4	AT/ATX Input power select (JAT1).....	22
2.6.5	Serial port 1 in RS-232/422/485 mode (JCOM1_SEL1).....	23
2.6.6	LCD Inverter connector (JBKL1)	23
2.6.7	On-board header for USB2.0 (JUSB1).....	24
2.6.8	On-board header for USB2.0 (JUSB2).....	24
2.6.9	Battery connector (JBAT1)	25
2.6.10	LCD backlight brightness adjustment (JBLK_CTRL1)	25
2.6.11	LVDS connector (JLVDS1).....	26
2.6.12	AMPLIFIER_R (JSPR1)	27
2.6.13	AMPLIFIER_L (JSPL1).....	27
2.6.14	SPI connector (JSPI1)	28
2.6.15	EC Debug connector (JEC1)	28
2.6.16	B2B connector (JB2B1)	29
2.6.17	Touch panel connector (JTP1)	30
2.6.18	General purpose I/O connector (JGPIO1).....	30

2.6.19	SATA Power connector (SATAPW1).....	31
2.7	ARC-BYT DB-A/B/C/D/E/F/G/H/K Overviews	32
2.7.1	ARC-BYT DB-A	32
2.7.2	ARC-BYT DB-B	32
2.7.3	ARC-BYT DB-C	32
2.7.4	ARC-BYT DB-D	33
2.7.5	ARC-BYT DB-E	33
2.7.6	ARC-BYT DB-F.....	33
2.7.7	ARC-BYT DB-G	34
2.7.8	ARC-BYT DB-H	34
2.7.9	ARC-BYT DB-K	34
2.8	ARC-BYT DB-A/B/C/D/E/F/G/H/K Connector list	35
2.8.1	ARC-BYT DB-A	35
2.8.2	ARC-BYT DB-B	35
2.8.3	ARC-BYT DB-C	35
2.8.4	ARC-BYT DB-D	35
2.8.5	ARC-BYT DB-E	35
2.8.6	ARC-BYT DB-F.....	36
2.8.7	ARC-BYT DB-G	36
2.8.8	ARC-BYT DB-H	36
2.8.9	ARC-BYT DB-K	36
2.9	ARC-BYT DB-D Connectors settings	38
2.9.1	Serial Port 1 connector (D_COM1).....	38
2.9.2	Serial Port 2 connector (D_COM2).....	38
2.10	ARC-BYT DB-E Jumpers & Connectors settings	39
2.10.1	CAN2.0 Switch (E_JCAN20)	39
2.10.2	For user update FW (E_JBOOT0).....	39
2.10.3	For user update FW (E_JIAP1)	40
2.11	ARC-BYT DB-F Connectors settings.....	42
2.12	ARC-BYT DB-G Connectors settings	43
2.12.1	Serial Port 1 connector (G_COM1)	43
2.12.2	Serial Port 2 connector (G_COM2)	43
2.12.3	Serial Port 3 connector (G_COM3)	44
2.13	ARC-BYT DB-H Jumpers settings.....	44
2.13.1	USB Power selector (H_USB_PWR_SEL1).....	44
2.14	ARC-BYT DB-H Connectors settings	45
2.14.1	Serial Port 1 connector (H_COM1).....	45
2.14.2	Serial Port 2 connector (H_COM2).....	45
2.15	ARC-BYT DB-K Connectors settings	46
2.15.1	Serial Port 1 connector (I_COM1)	46

2.15.2	Serial Port 2 connector (I_COM2)	46
3	BIOS Setup	47
3.1	Introduction	48
3.2	Starting Setup	48
3.3	Using Setup	49
3.4	Getting Help	50
3.5	In Case of Problems	50
3.6	BIOS setup	51
3.6.1	Main Menu	51
3.6.1.1	System Language	52
3.6.1.2	System Date	52
3.6.1.3	System Time	52
3.6.2	Advanced Menu	52
3.6.2.1	Trusted Computing	53
3.6.2.2	APCI Settings	53
3.6.2.3	AMT Configuration	55
3.6.2.4	PCH-FW Configuration	56
3.6.2.5	IT8528 Super IO Configuration	56
3.6.2.5.1	Serial Port 1 Configuration	57
3.6.2.5.2	Serial Port 2 Configuration	58
3.6.2.5.3	Serial Port 3 Configuration	58
3.6.2.5.4	Serial Port 4 Configuration	59
3.6.2.5.5	Serial Port 5 Configuration	59
3.6.2.6	H/W Monitor	60
3.6.2.7	S5 RTC Wake Settings	60
3.6.2.8	Serial Port Console Redirection	61
3.6.2.8.1	Legacy Console Redirection Settings	61
3.6.2.9	CPU Configuration	62
3.6.2.10	Intel TXT Configuration	62
3.6.2.11	SATA Configuration	63
3.6.2.12	Network Stack Configuration	64
3.6.2.13	CSM Configuration	64
3.6.2.14	USB Configuration	65
3.6.3	Chipset	66
3.6.3.1	System Agent (SA) Configuration	66
3.6.3.1.1	Graphics Configuration	67
3.6.3.1.2	Memory Configuration	68
3.6.3.2	PCH-IO Configuration	69
3.6.3.2.1	PCI Express Configuration	69
3.6.3.2.1.1	PCI Express Root Port5 (i210/211)	70

3.6.3.2.1.2 PCI Express Root Port8 (B2B mPCIe)	71
3.6.3.2.1.3 PCI Express Root Port12 (mPCIe)	72
3.6.3.2.2 USB Configuration.....	73
3.6.3.2.3 HD Audio Configuration	73
3.6.4 Security	74
3.6.4.1 Secure Boot menu.....	75
3.6.4.1.1 Key Management	76
3.6.5 Boot.....	76
3.6.6 Save and exit	77
3.6.6.1 Save Changes and Reset	78
3.6.6.2 Discard Changes and Reset	78
3.6.6.3 Restore Defaults.....	78
3.6.6.4 Launch EFI Shell from filesystem device	78

1. Getting Started

1.1 Safety Precautions

Warning!



Always completely disconnect the power cord from your chassis whenever you work with the hardware. Do not make connections while the power is on. Sensitive electronic components can be damaged by sudden power surges. Only experienced electronics personnel should open the PC chassis.

Caution!



Always ground yourself to remove any static charge before touching the CPU card. Modern electronic devices are very sensitive to static electric charges. As a safety precaution, use a grounding wrist strap at all times. Place all electronic components in a static-dissipative surface or static-shielded bag when they are not in the chassis.

1.2 Packing List

- 1 x ARC-1732
- 1 x Power Adapter
- 4 x screws for VESA



If any of the above items is damaged or missing, contact your retailer.

1.3 System Specifications

Component	
Mother Board	ARC-SKLU
CPU	6th Gen Intel® Core™ i5-6300U, 2-Core, 2.4GHz processor
CPU Cooler (Type)	Fanless Heatsink
Memory	One 260-pin SODIMM Socket Up to 16GB DDR4 2133 SDRAM
Power Supply	DC in
Adapter	60W power adaptor
Speaker	2 W*2
Wireless LAN	Optional USB or PCIe module
Bluetooth	Optional
Operating System	Ubuntu, Windows 7/ 10
Expansion Card	Compatible to all ARC-BYT DB modules (BIOS auto adjusted)
Other Component	Logitech detect BD
Storage	
Hard Disk Drive	1 x 2.5" Drive Bay, HDD
Solid State Drive	1 x 2.5" Drive Bay, HDD
Other Storage Device	1 x mSATA supports on the 1st Mini PCIe slot, Auto switch for mSATA or Mini PCIe
Panel	
LCD Panel	17", 1280 x 1024
B/L Inverter/Converter	LCD built in
Touch Screen	P-cap
Touch Controller	EETI
External I/O	
Serial Port	1 x DB-9 COM1 (RS-232/422/485, selectable by BIOS & JUPMER, RS-485 supports Auto Flow, Pin-9 selected by Ring/+5V/+12V) 1 x DB-9 COM2 (RS-232, Pin-9 selected by Ring/+5V/+12V)
USB Port	4 x USB3.0 (2 x Double deck)
DIO Port	16-bit GPIO
Audio Port	Realtek ALC892 HD codec
LAN Port	1 x I219LM PHY, 1 x Intel I211AT GbE controller
Wireless LAN Antenna	3 x Antenna
Indicator Light	HDD LED, Power LED (Green for Power, Yellow for HDD)
Expansion Slots	1* mini PCIe full size (support half size) 1 x mSATA supports on the 1st Mini PCIe slot, Auto switch for mSATA or Mini PCIe
Internal I/O	1 x SATA connector & 1 x 2-pin wafer SATA power connector

ARC-1732

	<p>1 x 2 x 20-pin Hirose connector for 2 x 24-bit LVDS</p> <p>1 x 5-pin lockable connector for inverter backlight control with dimming (PWM/DC mode & backlight brightness selected by BIOS as standard)</p> <p>2 x 3-pin header for LCD backlight brightness adjustment (dimming) (as ECM-BYT2 w/ light/dark, VR, DC/PWM)</p> <p>1 x 3-pin header for CMOS (protect*Clear)</p> <p>1 x 2 x 3-pin header for COM1/ 2 pin 9 signal selection (+5, +12, Ring, selected by jumper)</p> <p>1 x 2 x 3-Pin header for SPI</p> <p>1 x 2 x 6-pin wafer for front panel</p> <p>1 x 3-pin header for Power mode(AT/ATX)</p> <p>1 x Buzzer</p> <p>2 x 2-pin wafer for speaker out (as ARC-SKLU)</p> <p>1 x 5-pin 90 degree pin header for touch connector</p> <p>1 x 1 x 5 pin wafer for 1 USB 2.0 (For USB WiFi)</p> <p>2 x 6 pin wafer for SM bus (Reserved for smart battery)and 8bit GPIO</p> <p>1 x 80-pin board to board connector for Expansion board (Hirose FX18-80P-0.8SH & FX18-80S-0.8SH)</p>
Mechanical	
Power Type	AT/ATX
Power Requirement	<p>DC +12V ~ +26V, wide voltage single power input</p> <p>TVS component for surge protection</p> <p>Reverse current/voltage protection</p>
ACPI	Single power ATX Support S0, S3, S4, S5 and ACPI 3.0 Compliant
Power Connector Type	2.5mm Lockable DC Jack, co-lay with phoenix connector
Dimension	390 x 240 x 60mm
Weight	5.2 Kgs
Color	Front: Die-Casting with Cover lens; Rear: Black Casting-Aluminum
Fanless	Yes
OS Support	Linux, Ubuntu, Windows 7/10
Reliability	
EMI Test	CE/ FCC class B
Dust and Rain Test	Front Panel IP65, Rear IP41 except I/O
Vibration Test	<p>Random Vibration Operation:</p> <ol style="list-style-type: none"> 1. PSD: 0.03622G²/Hz , 2.0 Grms 2. operation mode 3. Test Frequency : 5-500Hz 4. Test Axis : X,Y and Z axis

	<p>5. 30 minutes per each axis</p> <p>6. IEC 60068-2-64 Test:Fh</p> <p>7. Storage : CF or SSD</p> <p>Sine Vibration test (Non-operation)</p> <p>1 Test Acceleration : 2G</p> <p>2 Test frequency : 5~500 Hz</p> <p>3 Sweep : 1 Oct/ per one minute. (logarithmic)</p> <p>4 Test Axis : X,Y and Z axis</p> <p>5 Test time :10 min. each axis</p> <p>6 System condition : Non-Operating mode</p> <p>7. Reference IEC 60068-2-6 Testing procedures</p> <p>Package vibration test</p> <p>1. PSD: 0.026G²/Hz , 2.16 Grms</p> <p>2. Non-operation mode</p> <p>3. Test Frequency : 5-500Hz</p> <p>4. Test Axis : X,Y and Z axis</p> <p>5. 30 min. per each axis</p> <p>6. IEC 60068-2-64 Test:Fh</p>
Mechanical Shock Test	<p>1. Wave form : Half Sine wave</p> <p>2. Acceleration Rate : 20g for operation mode</p> <p>3. Duration Time : 11ms</p> <p>4. No. of Shock : +/- X,Y,Z axis 3 times</p> <p>5. Test Axis: +/- X,Y,Z axis</p> <p>6. Operation mode</p> <p>7. Reference IEC 60068-2-27 Testing procedures Test Eb : Shock Test</p>
Drop Test	<p>Package drop test</p> <p>1 One corner , three edges, six faces</p> <p>2 ISTA 2A, IEC-60068-2-32 Test:Ed</p>
Operating Temperature	<p>-10 ~ +50 degree C SSD</p> <p>0 ~ 40 degree C HDD</p>
Operating Humidity	0 ~ 90% Relative Humidity, Non-condensing
Storage Temperature	-20 ~ 60 degree
Compliant with following Flexible Expansion Modules	
ARC-BYT DB-A	4 x USB3.0 module
ARC-BYT DB-B	3 x Audio Jack (Line in/Line out/Mic in)+HDMI
ARC-BYT DB-C	HDMI + Mini PCIe (w/ SIM slot)

ARC-1732

ARC-BYT DB-D	2 x COM Isolation module
ARC-BYT DB-G	3 x COM (w/o isolation, RS-232 only)
ARC-BYT DB-H	2COM (RS-232) + 1USB 2.0
ARC-BYT DB-K	2COM (RS-232) + 1LAN
ARC-BYT DB-E	12-bit GPIO+CAN Bus
ARC-BYT DB-F	CAN Bus for OBDII



Note: Specifications are subject to change without notice.

1.4 System Overview

1.4.1 I/O View

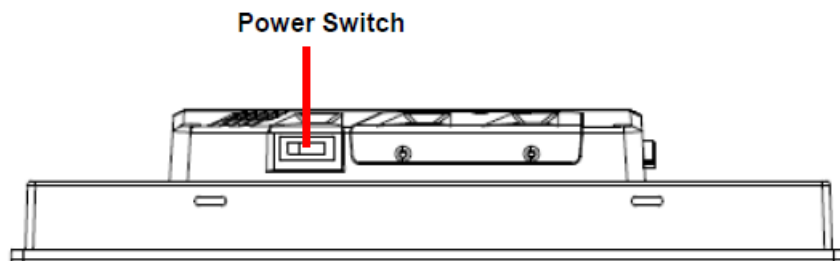
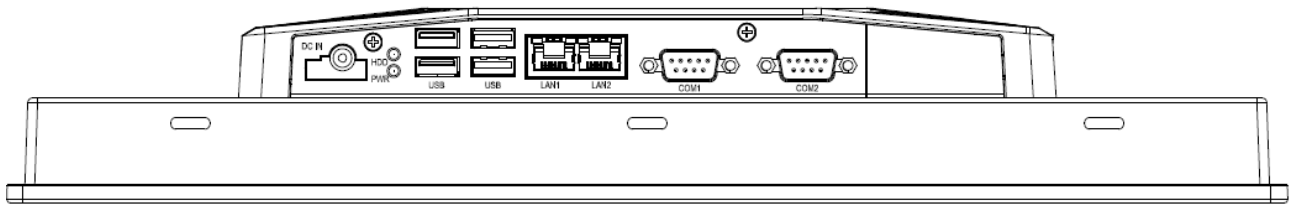

Connectors

Label	Function	Note
DC IN	DC Power-in connector	
COM1/2	Serial port 1/2 connector	DB-9 male connector
USB	4 x USB 3.0 connector	
LAN1/2	RJ-45 Ethernet 1/2	
HDD	HDD indicator	
PWR	System power indicator	
Power Switch	Power on button	

1.5 System Dimensions

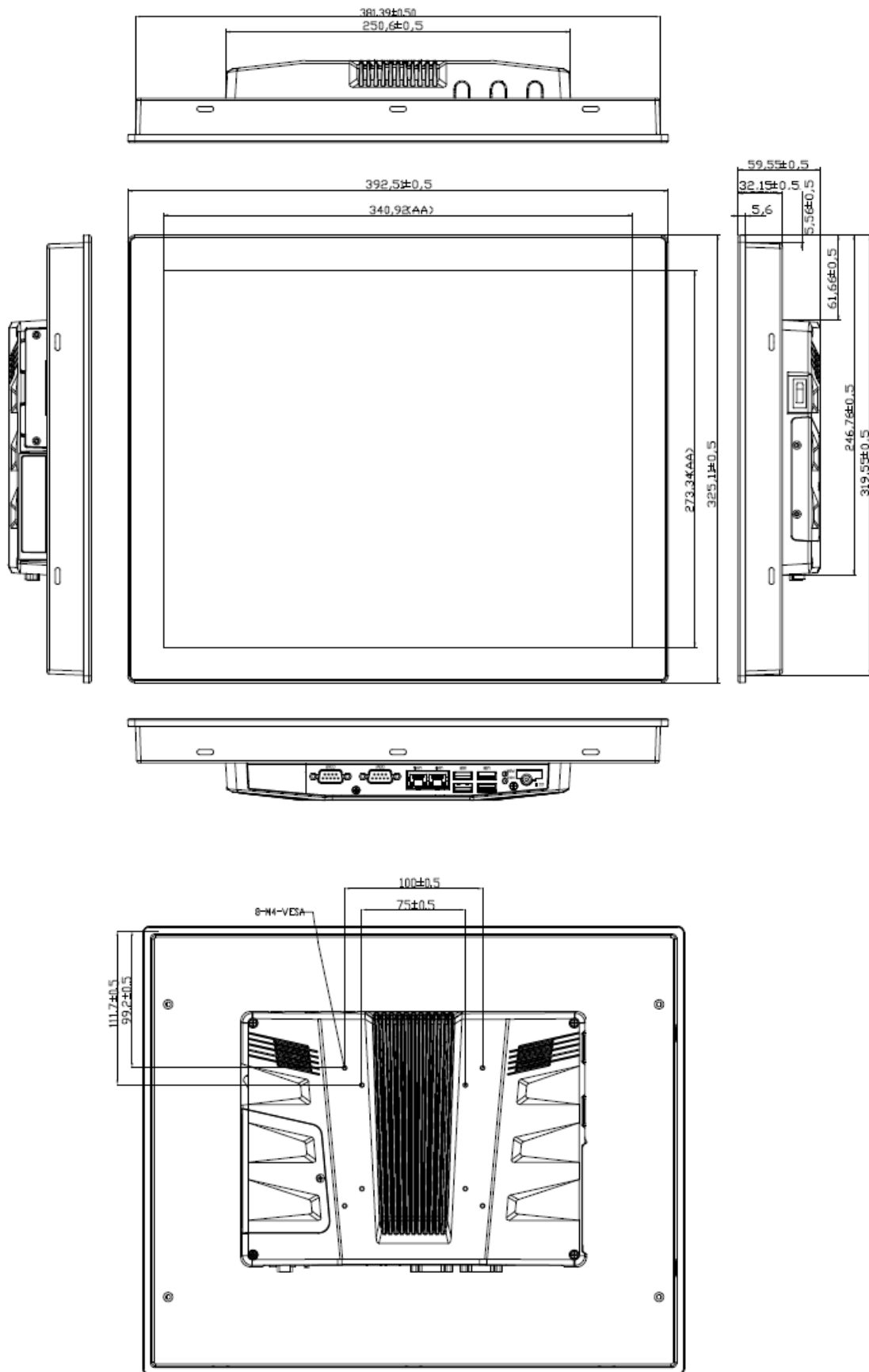

(Unit: mm)

2. Hardware Configuration

For advanced information, please refer to:

- 1- ARC-SKLU, ARC-BYT DB-A/B/C/D/E/F/G/H/K included in this manual.

2.1 ARC-1732 connector mapping

2.1.1 Serial port 1 connector (COM1)

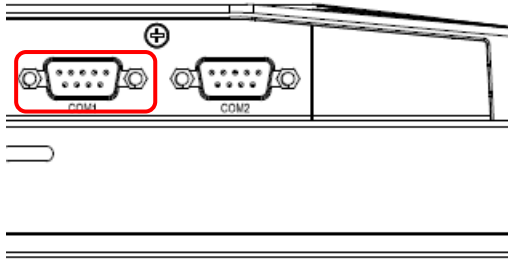

RS-485

Signal	PIN	PIN	Signal
DATA-	1	6	NC
DATA+	2	7	NC
NC	3	8	NC
NC	4	9	NC
GND	5		

Please set BIOS & JCOM2_SEL2

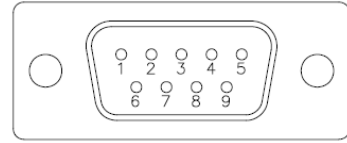

RS-232

Signal	PIN	PIN	Signal
NDCDA#	1	6	NDSRA#
NRXDA	2	7	NRTSA#
NTXDA	3	8	NCTSA#
NDTRA#	4	9	NRIA#
GND	5		

RS-422

Signal	PIN	PIN	Signal
TxD-	1	6	NC
TxD+	2	7	NC
RxD+	3	8	NC
RxD-	4	9	NC
GND	5		

Please set BIOS & JCOM2_SEL2

2.1.2 Serial port 2 connector (COM2)

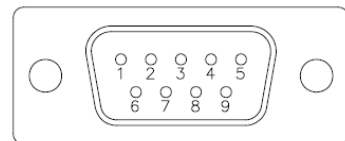
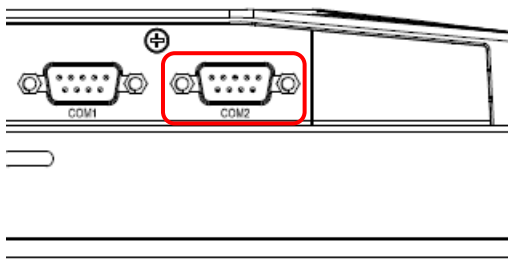

Signal	PIN	PIN	Signal
NDCDB#	1	6	NDSRB#
NRXDB	2	7	NRTSB#
NTXDB	3	8	NCTSB#
NDTRB#	4	9	NRIB#
GND	5		

2.2 Installing Hard Disk & Memory

Step 1. Memory Installation: Remove 3 screws to release the chassis cover, and remove it.

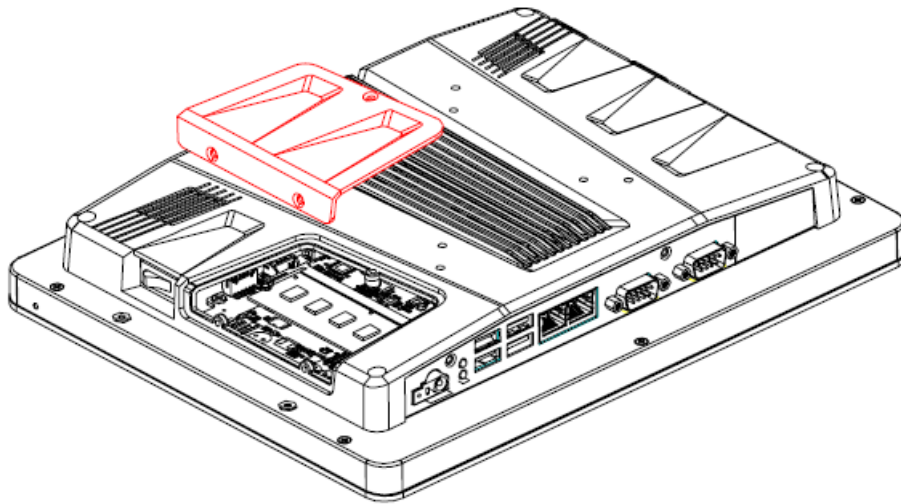
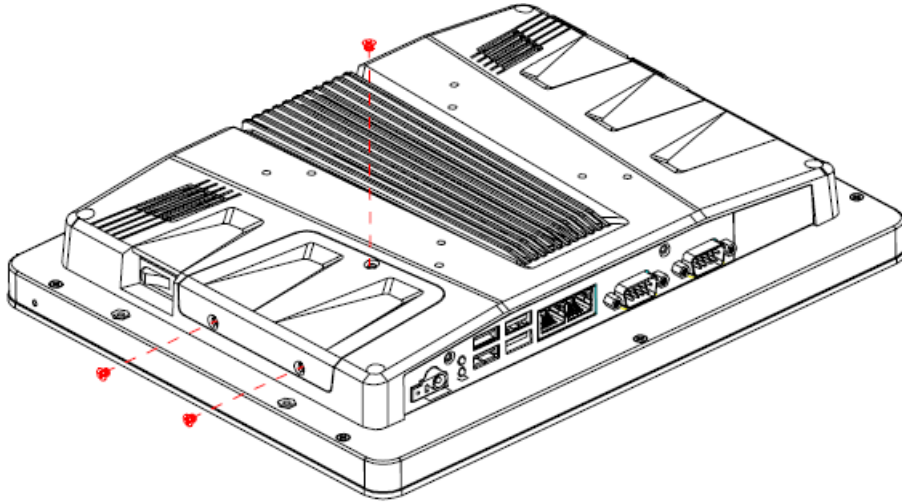

Step 2.1 Insert the SODIMM into the memory socket.

Step 2.2 Re-assemble your system back through previous steps to complete the installation.

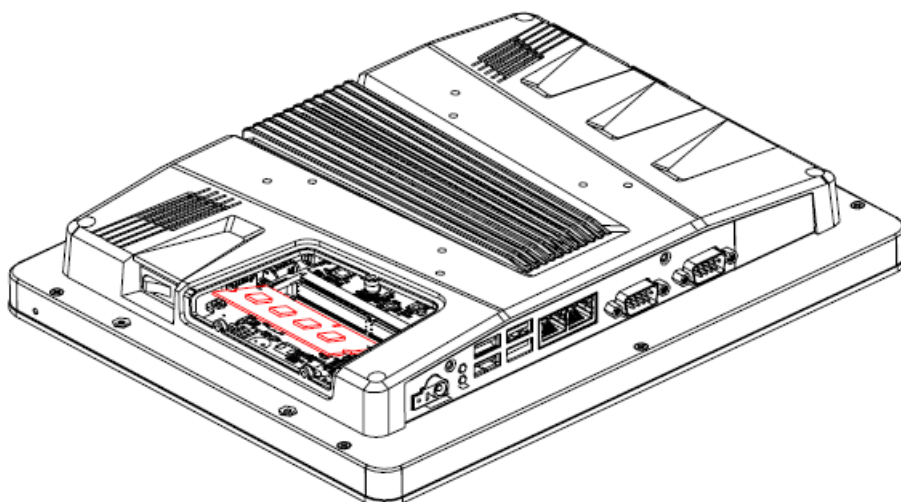

Step 3. HDD Installation: Insert the HDD into the Drive Bay and fasten 2 screws.

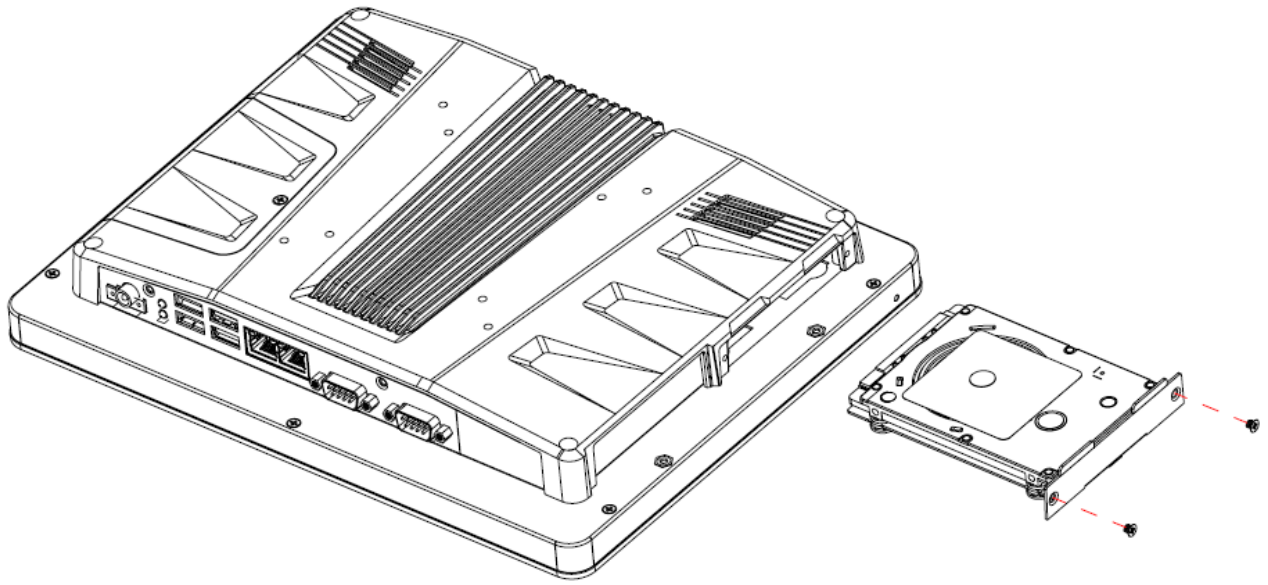

2.3 Installing ARC-BYT DB

Step 1. Unfasten 2 screws of the HDD bracket and take it off.

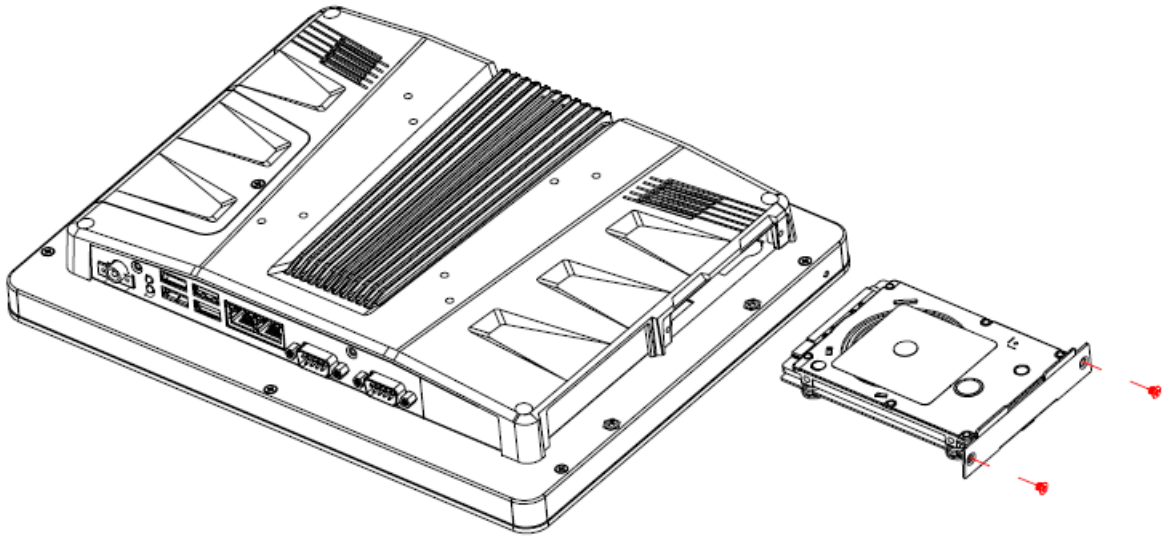

Step 2. Remove 4 screws to release the chassis cover, and remove it.

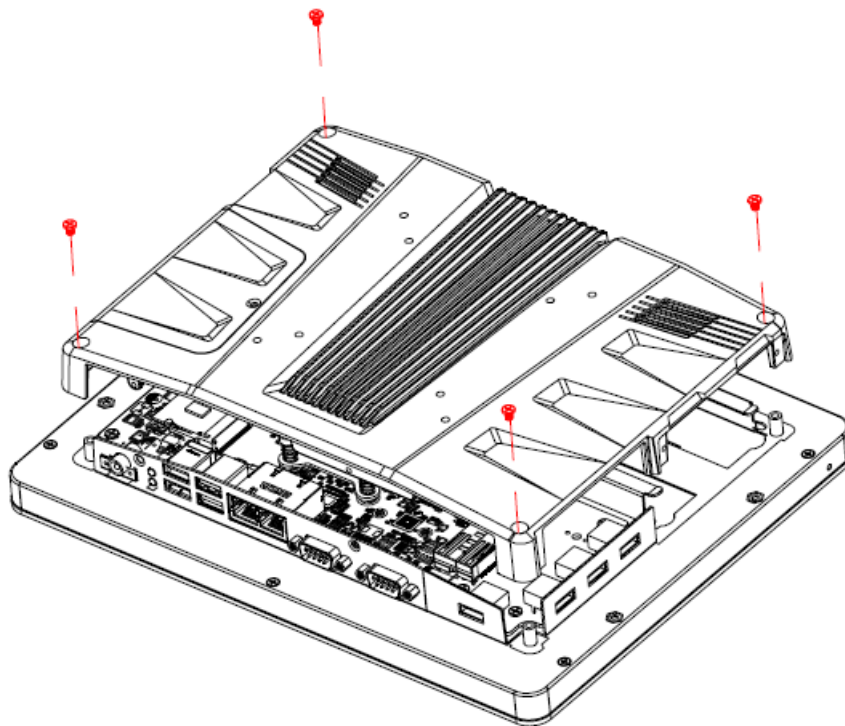

ARC-1732

Step 2.1 Insert the ARC-BYT DB into the socket and fasten 3 screws.

Step 2.2 Re-assemble your system back through previous steps to complete the installation

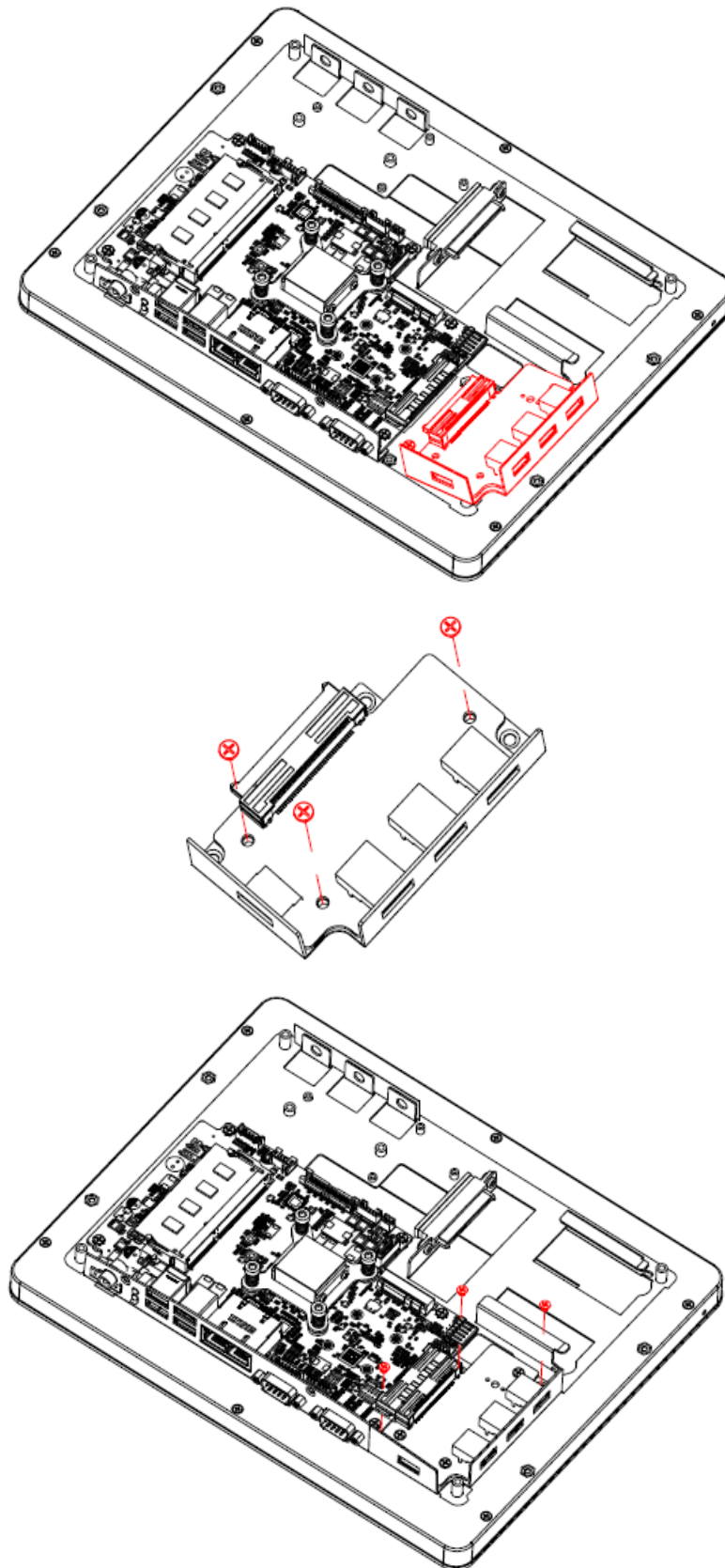

2.4 ARC-SKLU Overviews

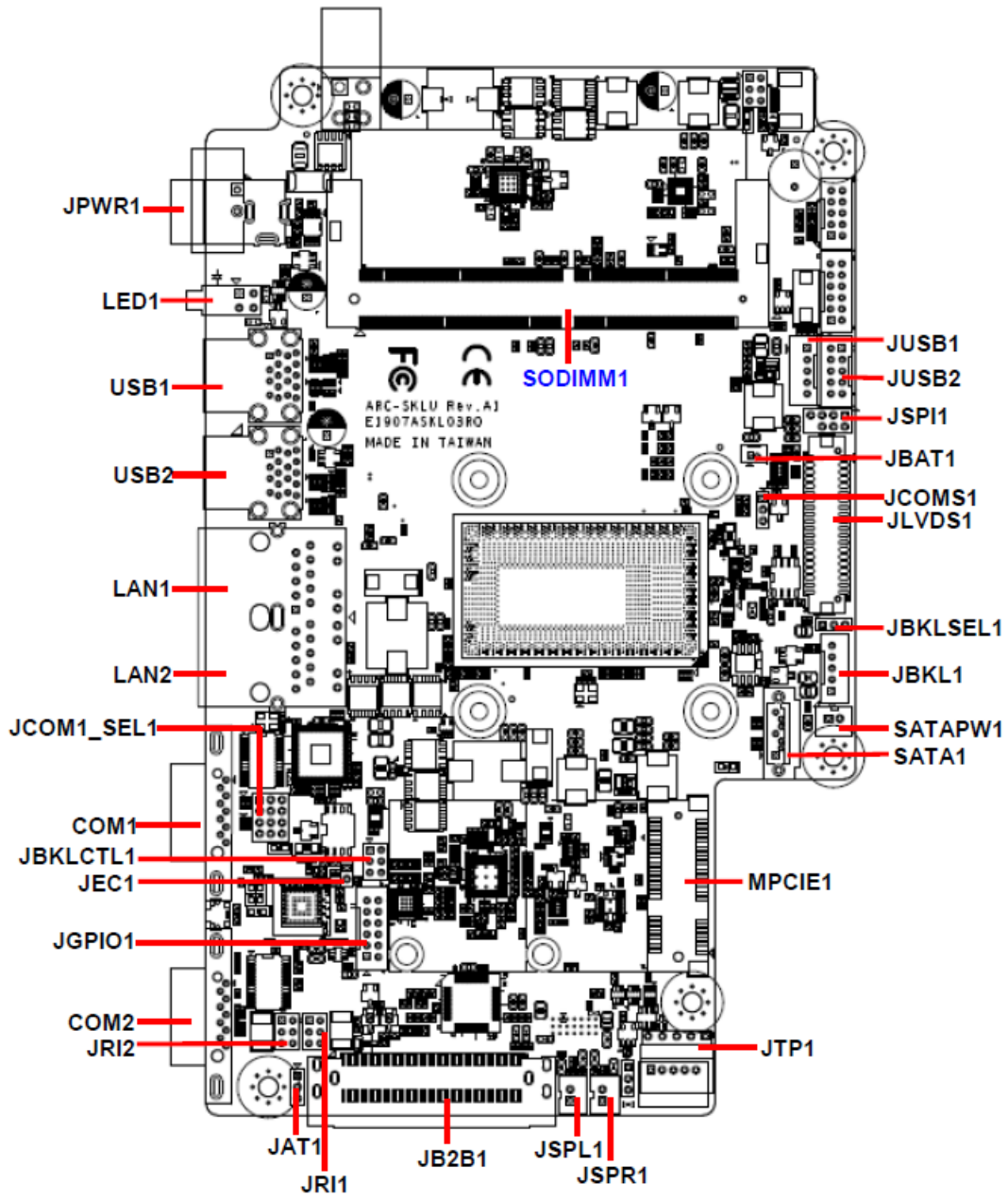

2.5 ARC-SKLU Jumper and Connector list

Jumper

Label	Function	Note
JCOMS1	Clear CMOS	3 x 1 header, pitch 2.00mm
JRI1/2	Serial port 1/2 pin9 signal select	3 x 2 header, pitch 2.00mm
JCOM1_SEL1	Serial port 1 in RS-232/422/485 mode	4 x 3 header, pitch 2.00mm
JBKLSEL1	LCD backlight brightness adjustment	3 x 1 header, pitch 2.00mm
JAT1	AT/ATX Input power select	3 x 1 header, pitch 2.00mm

Connectors

Label	Function	Note
SODIMM1	1 x 260-Pin DDR4 2133MHz SO-DIMM	
JBKL1	LCD Inverter connector	5 x 1 wafer, pitch 2.00mm
COM1/2	Serial Port 1/2 connector	D-sub 9 pin, male
JTP1	Touch panel connector	5 x 1 header, pitch 2.54mm
JSPR1	AMPLIFIER_R	2 x 1 wafer, pitch 2.00mm
JSPL1	AMPLIFIER_L	2 x 1 wafer, pitch 2.00mm
JB2B1	B2B connector	40 x 2 wafer, pitch 0.80mm
JBKLCTL1	LCD backlight brightness adjustment	3 x 2 header, pitch 2.00mm
LED1	HDD/Power LED indicator	
JLVDS1	LVDS connector	DIN 40-pin wafer, pitch 1.25mm
USB1/2	USB connector 1/2	
JUSB1	On-board header for USB2.0	5 x 1 wafer, pitch 2.00mm
JUSB2	On-board header for USB2.0	5 x 2 wafer, pitch 2.00mm
LAN1/2	RJ-45 Ethernet 1/2	
MPCIE1	Mini-PCle connector	
JBAT1	Battery connector	2 x 1 wafer, pitch 1.25mm
JGPIO1	General purpose I/O connector	6 x 2 wafer, pitch 2.00mm
JPWR1	Power connector	
JSPI1	SPI connector	4 x 2 header, pitch 2.00mm
JEC1	EC Debug connector	2 x 1 header, pitch 2.00 mm
SATA1	Serial ATA connector	
SATAPW1	SATA Power connector	2 x 1 wafer, pitch 2.00mm

2.6 ARC-SKLU Jumpers & Connectors settings

2.6.1 Clear CMOS (JCOMS1)

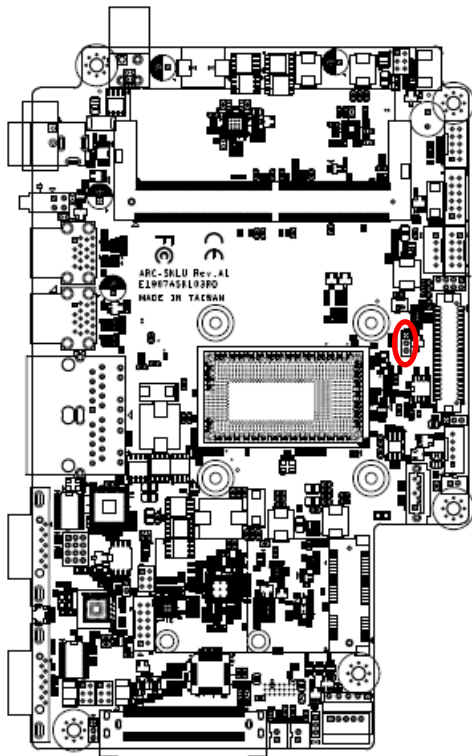

Protect*

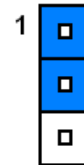

Clear CMOS



*Default

2.6.2 Serial port 1/2 pin9 signal select (JRI1/JRI2)

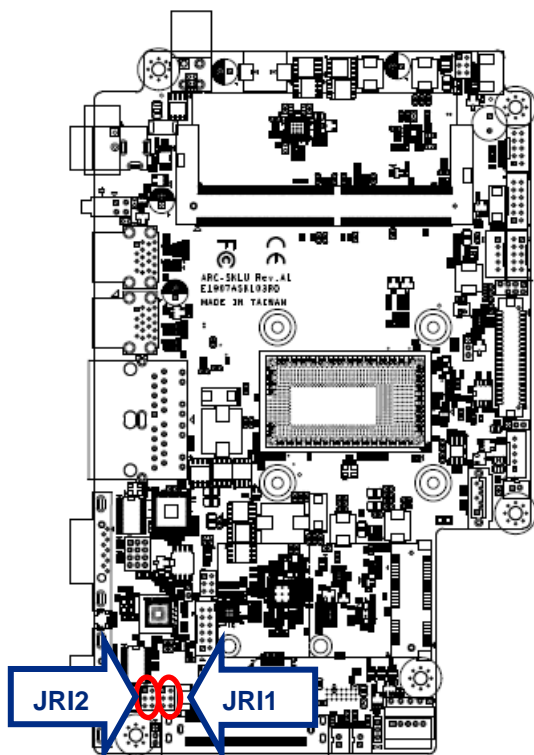

Ring*

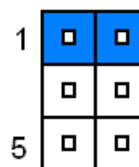

+5V

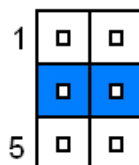

+12V

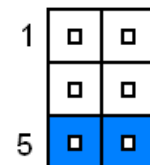

* Default

2.6.3 LCD backlight brightness adjustment (JBKLSEL1)

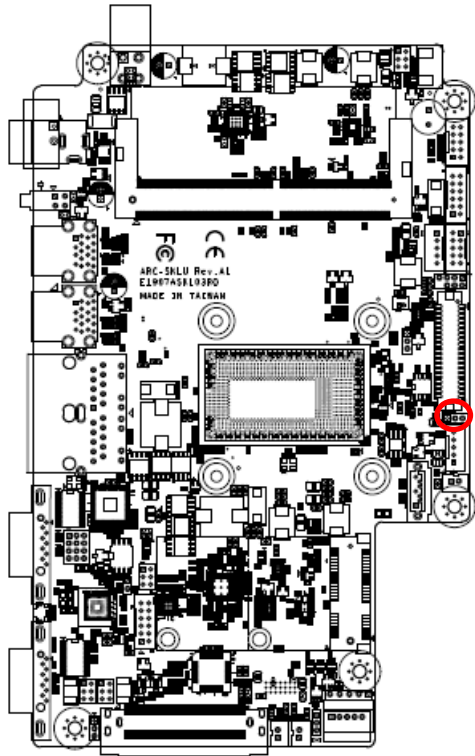

PWM Mode*

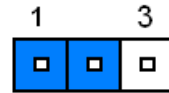

DC Mode

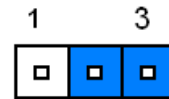

* Default

2.6.4 AT/ATX Input power select (JAT1)

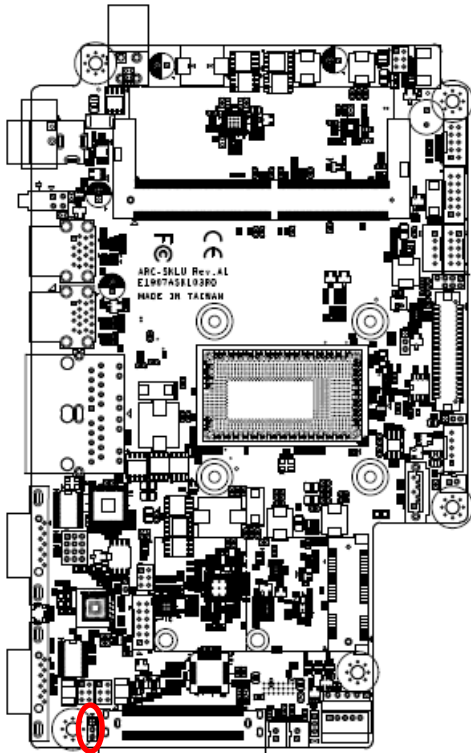

ATX*

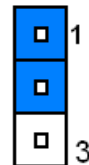

AT

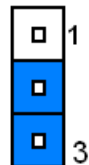

* Default

2.6.5 Serial port 1 in RS-232/422/485 mode (JCOM1_SEL1)

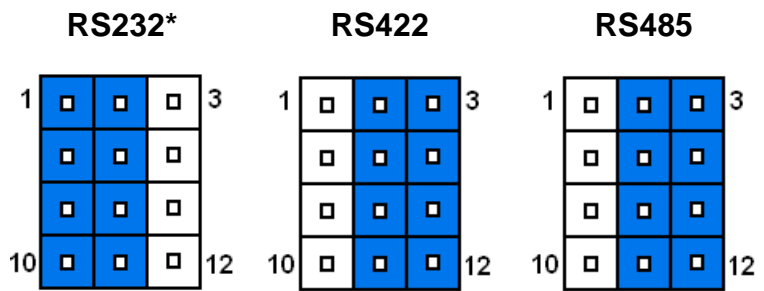
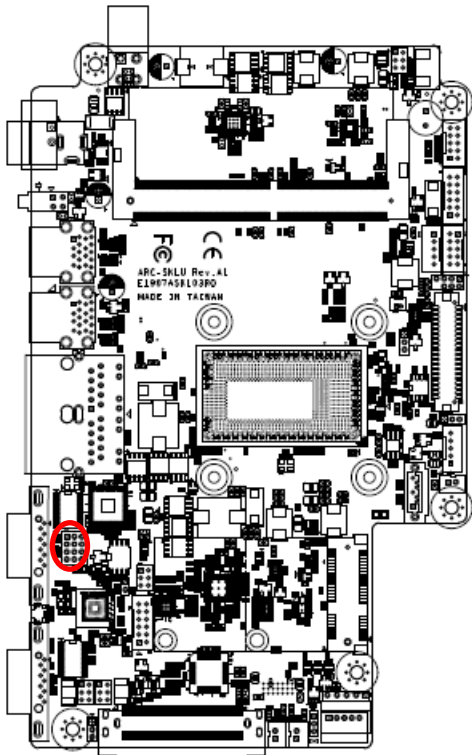

PIN	Signal	PIN	Signal	PIN	Signal
12	422RX1-	11	COM1-4	10	NDTRA#
9	485_422TX1+	8	COM1-2	7	NRXDA
6	422RX1+	5	COM1-3	4	NTXDA
3	485_422TX1-	2	COM1-1	1	NDCDA#

Note:

This connector is available after modify the mode of COM1 in BIOS setting.

* Default

2.6.6 LCD Inverter connector (JBKL1)

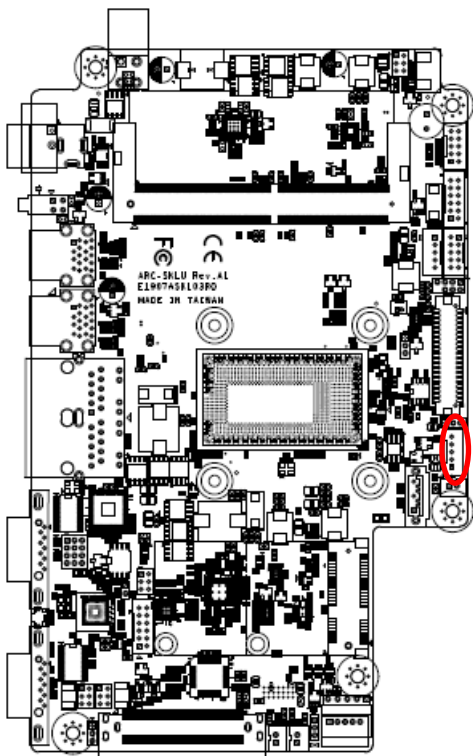

Signal	PIN
+5V	5
LVDS_BKLT_CTL	4
LVDS_BKLT_EN	3
GND	2
+12V	1

2.6.7 On-board header for USB2.0 (JUSB1)

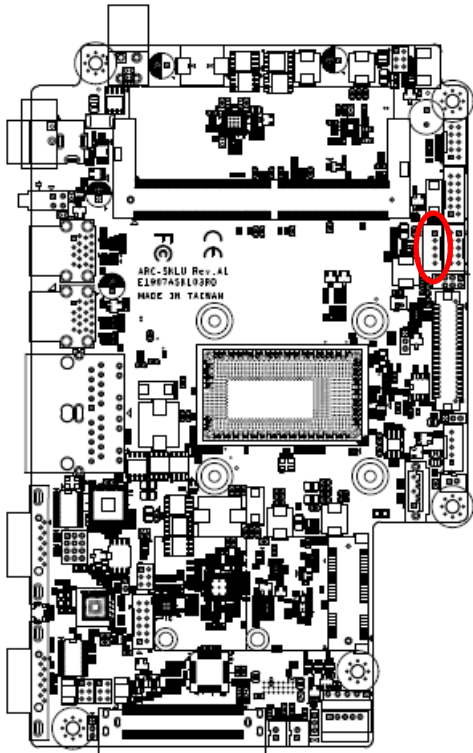

Signal	PIN
+5VSB	1
USB_z_PN10	2
USB_z_PP10	3
GND	4
GND	5

2.6.8 On-board header for USB2.0 (JUSB2)

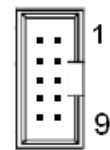
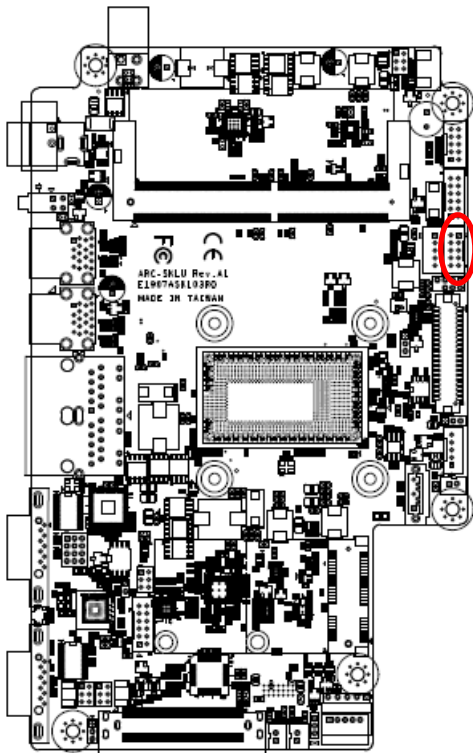

Signal	PIN	PIN	Signal
+5VSB	2	1	+5VSB
USB_z_PN6	4	3	USB_z_PN5
USB_z_PP6	6	5	USB_z_PP5
GND	8	7	GND
GND	10	9	GND

2.6.9 Battery connector (JBAT1)

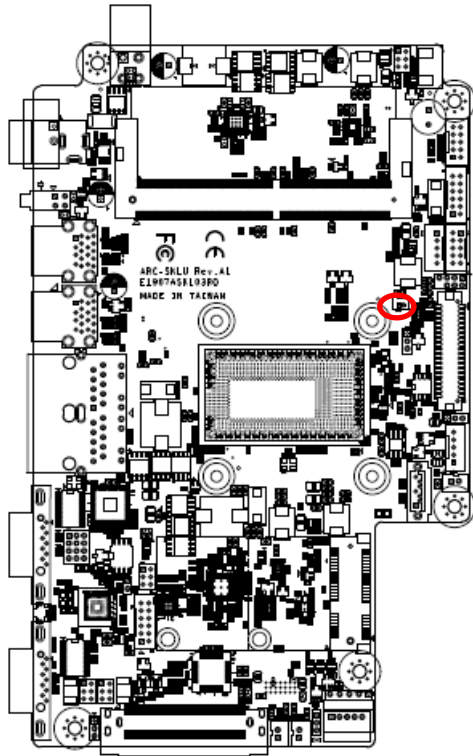

1

Signal	PIN
+RTCBAT	1
GND	2

2.6.10 LCD backlight brightness adjustment (JBLK_CTRL1)

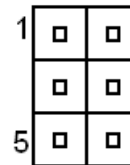
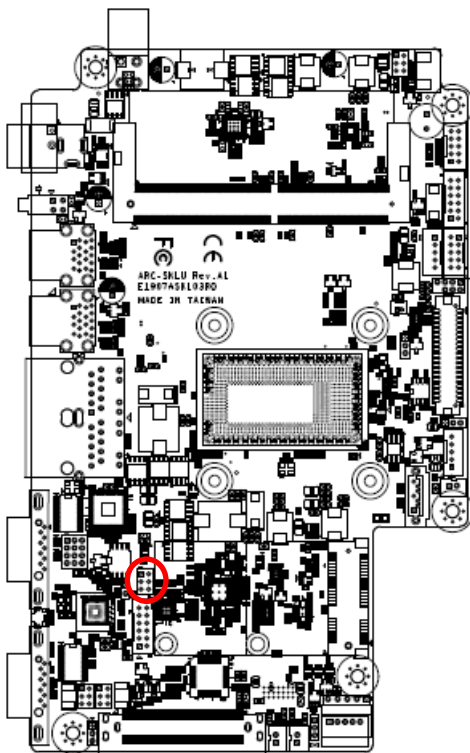

PIN	Signal	Note
1-2	BLK_VR_MOD	VR must select 10K/1%
3-4	BLK_BRI_UP	Low pulse button for backlight brighter
5-6	BLK_BRI_DN	Low pulse button for backlight dim

2.6.11 LVDS connector (JLVDS1)

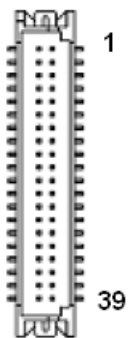
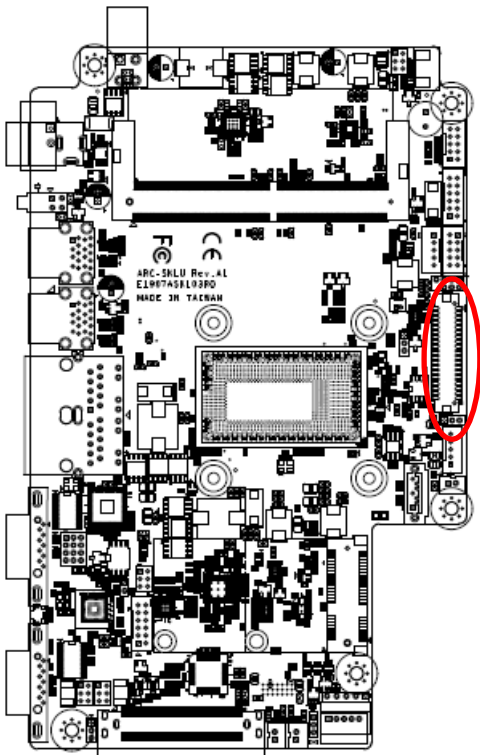

Signal	PIN	PIN	Signal
+5V	2	1	+3.3V
+5V	4	3	+3.3V
NC	6	5	NC
GND	8	7	GND
LVDS_DATA0_P	10	9	LVDS_DATA1_P
LVDS_DATA0_N	12	11	LVDS_DATA1_N
GND	14	13	GND
LVDS_DATA2_P	16	15	LVDS_DATA3_P
LVDS_DATA2_N	18	17	LVDS_DATA3_N
GND	20	19	GND
LVDS_DATA4_P	22	21	LVDS_DATA5_P
LVDS_DATA4_N	24	23	LVDS_DATA5_N
GND	26	25	GND
LVDS_DATA6_P	28	27	LVDS_DATA7_P
LVDS_DATA6_N	30	29	LVDS_DATA7_N
GND	32	31	GND
LVDS_CLK1_P	34	33	LVDS_CLK2_P
LVDS_CLK1_N	36	35	LVDS_CLK2_N
GND	38	37	GND
+12V	40	39	+12V

2.6.12 AMPLIFIER_R (JSPR1)

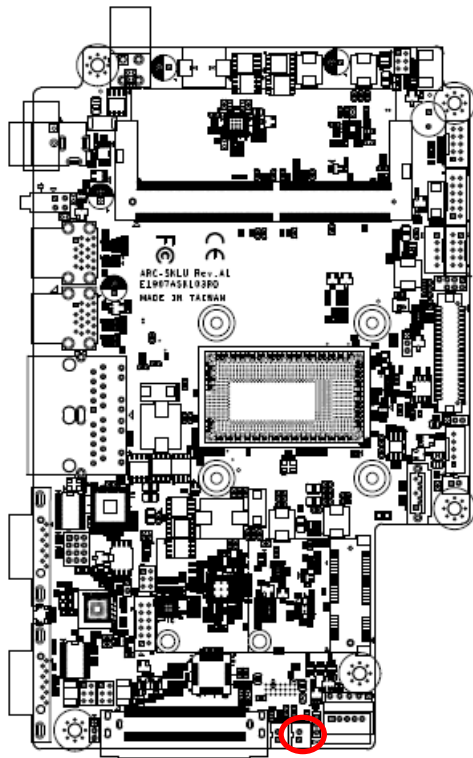

Signal	PIN
SPK_R-	2
SPK_R+	1

2.6.13 AMPLIFIER_L (JSPL1)

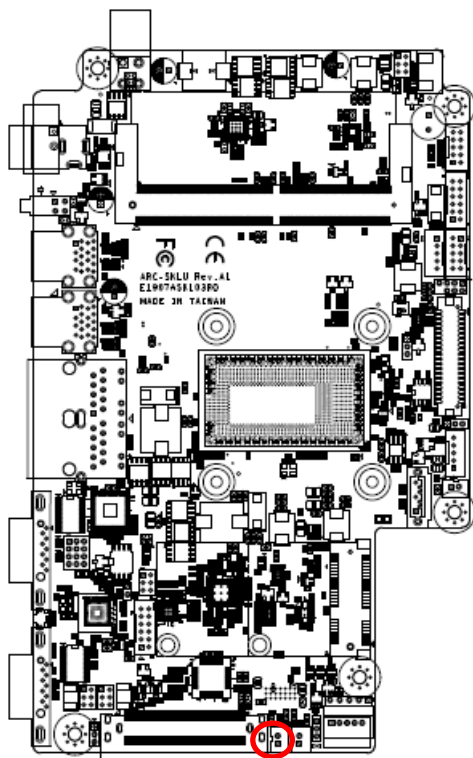

Signal	PIN
SPK_L-	2
SPK_L+	1

2.6.14 SPI connector (JSPI1)

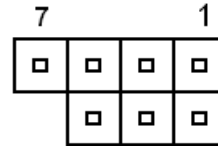
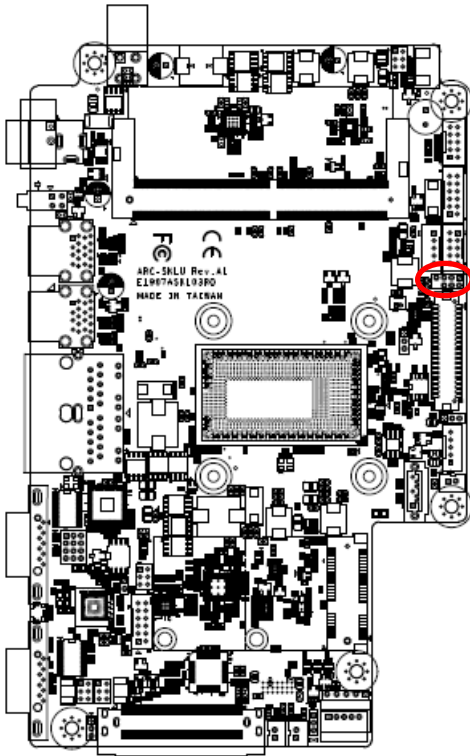

Signal	PIN	PIN	Signal
+3.3VSB	1	2	GND
SPI0_CS0#	3	4	SPI_CLK
SPI_SO	5	6	SPI_SI
HOLD#	7		

2.6.15 EC Debug connector (JEC1)

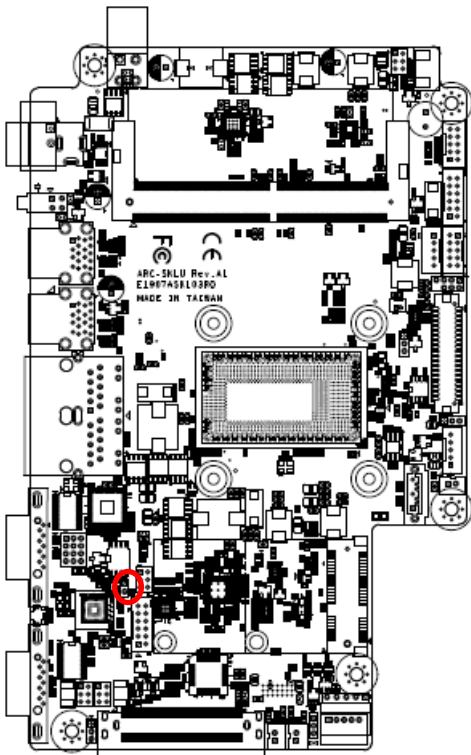

Signal	PIN
EC_SMCLK_DEBUG	1
EC_SMDAT_DEBUG	2

2.6.16 B2B connector (JB2B1)

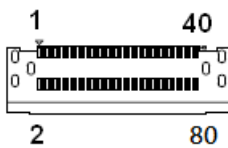
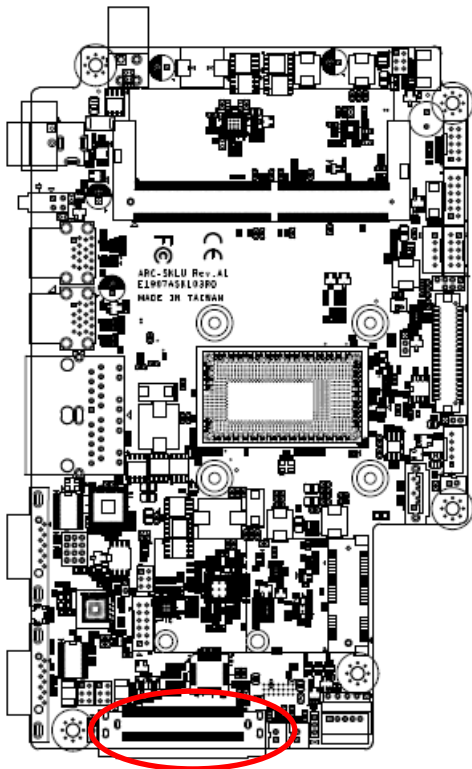

Signal	PIN	PIN	Signal
GND	1	41	GND
GND	2	42	GND
+12V	3	43	GND
+12V	4	44	GND
GND	5	45	GND
LPC_SERIRQ	6	46	+5VSB
LPC_LFRAME#	7	47	+5VSB
CLK3_LPC_B2B	8	48	+5VSB
LPC_AD0	9	49	+5VSB
LPC_AD1	10	50	+5VSB

Signal	PIN	PIN	Signal
LPC_AD2	11	51	GND
LPC_AD3	12	52	USB_PP8
PS_ON_B2B	13	53	USB_PN8
PLT_RST#	14	54	GND
PCH_SLP_S3#	15	55	SMBCLK
HDMI_HPD	16	56	SMBDATA
GND	17	57	GND
HDMI1_CTRL_CLK	18	58	BOARD_ID
HDMI1_CTRL_DAT	19	59	PCIEUSB3_PONRSTB
GND	20	60	PCIEUSB3_SMIB_INT#
HDMI1_TXN_2	21	61	B2BPCIE_WAKE#
HDMI1_TXP_2	22	62	RST_B2BPCIE#
GND	23	63	B2BPCIE_CLK_REQ#
HDMI1_TXN_1	24	64	GND
HDMI1_TXP_1	25	65	PCIE_TXN8
GND	26	66	PCIE_TXP8
HDMI1_TXN_0	27	67	GND
HDMI1_TXP_0	28	68	PCIE_RXN8
GND	29	69	PCIE_RXP8
HDMI1_CLKN	30	70	GND
HDMI1_CLKP	31	71	CLK_B2BPCIE_N2
GND	32	72	CLK_B2BPCIE_P2
GND	33	73	GND
MIC_RIN	34	74	GND
MIC_LIN	35	75	MIC1_JD
GND	36	76	GND
LINEOUT1_JD	37	77	LINE1_JD
LINEOUT_R	38	78	LINE1_RIN
LINEOUT_L	39	79	LNE1_LIN
GND	40	80	GND

2.6.17 Touch panel connector (JTP1)

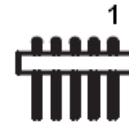
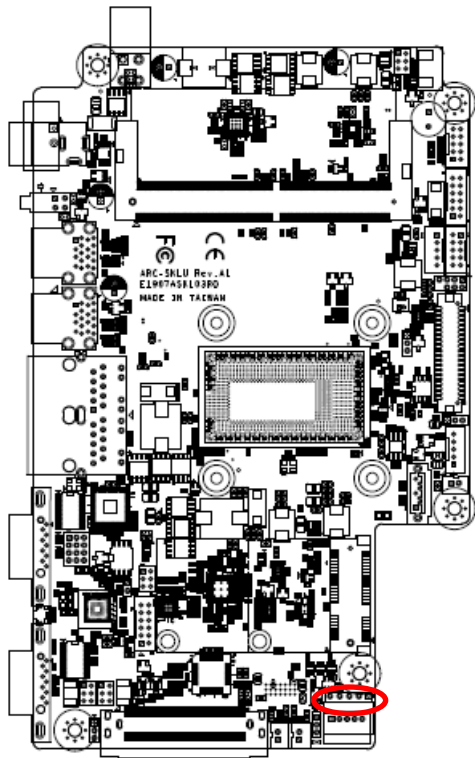

Signal	PIN
Y-	1
Y+	2
SENSE	3
X-	4
X+	5

2.6.18 General purpose I/O connector (JGPIO1)

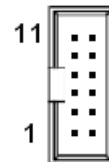
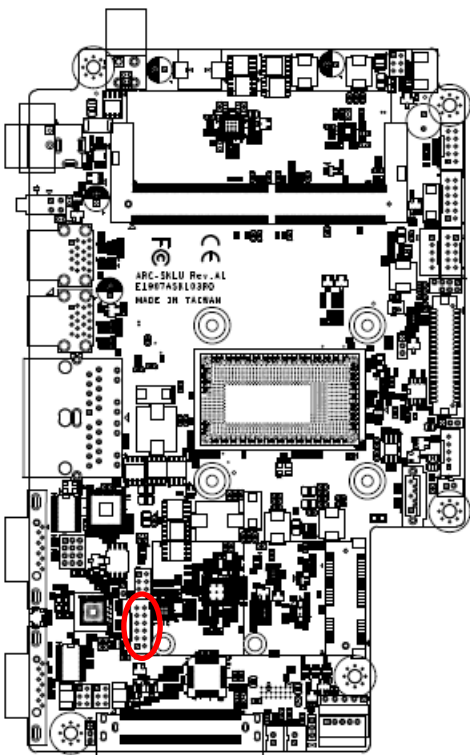

Signal	PIN	PIN	Signal
+3.3V	11	12	GND
SMB_DATA	9	10	SMB_CLK
DIO_GP23	7	8	DIO_GP13
DIO_GP22	5	6	DIO_GP12
DIO_GP21	3	4	DIO_GP11
DIO_GP20	1	2	DIO_GP10

2.6.19 SATA Power connector (SATAPW1)

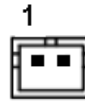
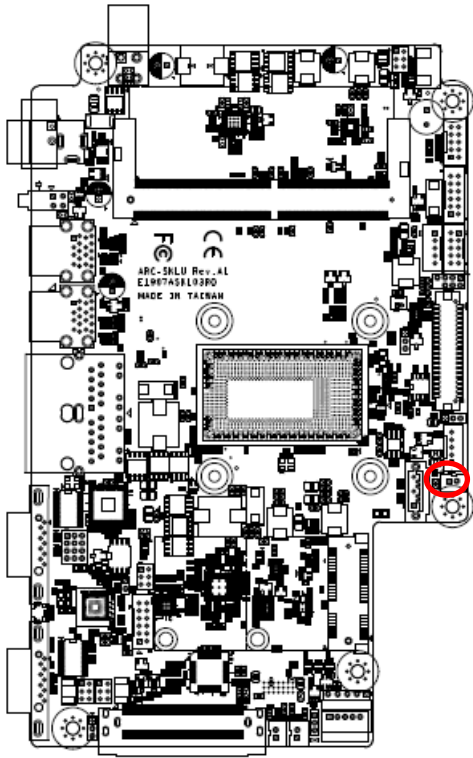

Signal	PIN
GND	1
+5V	2

2.7 ARC-BYT DB-A/B/C/D/E/F/G/H/K Overviews

2.7.1 ARC-BYT DB-A

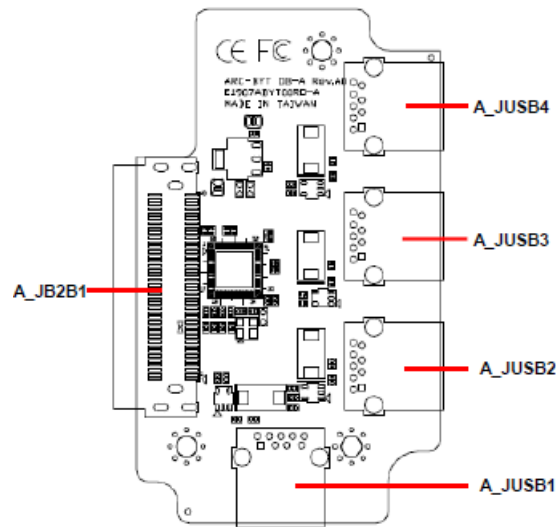

2.7.2 ARC-BYT DB-B

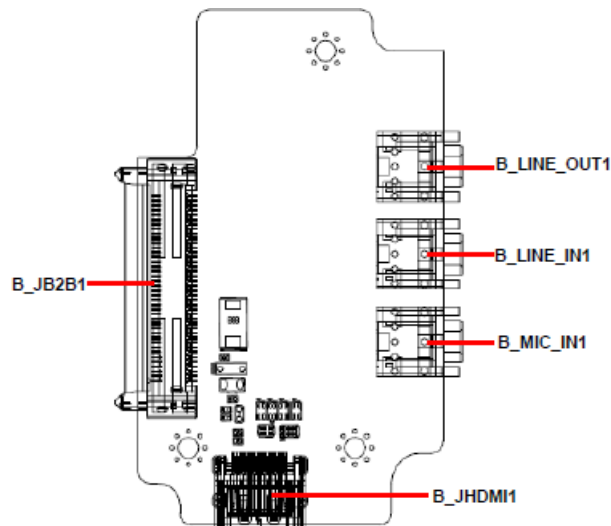

2.7.3 ARC-BYT DB-C

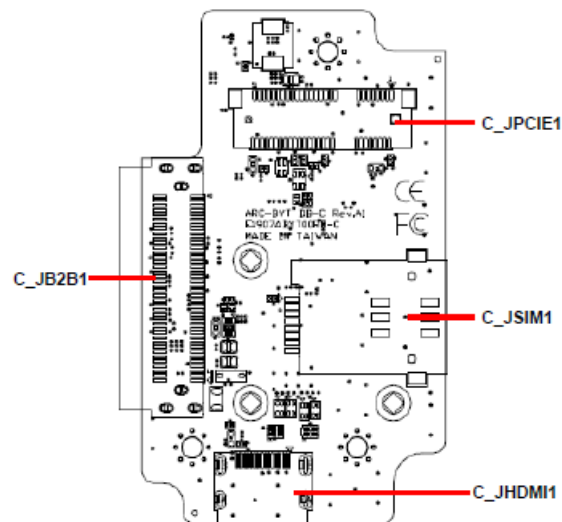

2.7.4 ARC-BYT DB-D

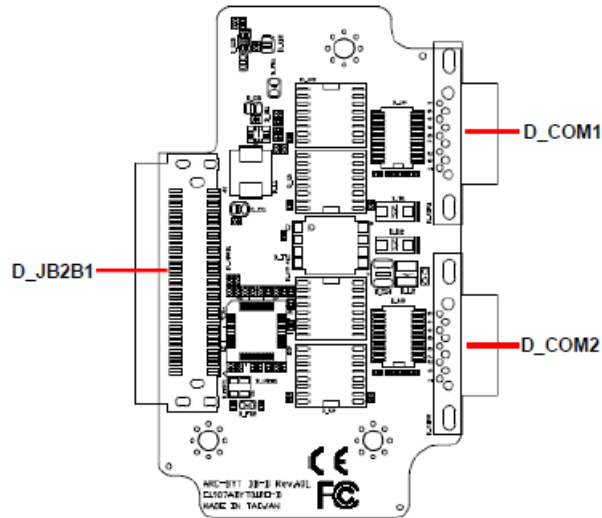

2.7.5 ARC-BYT DB-E

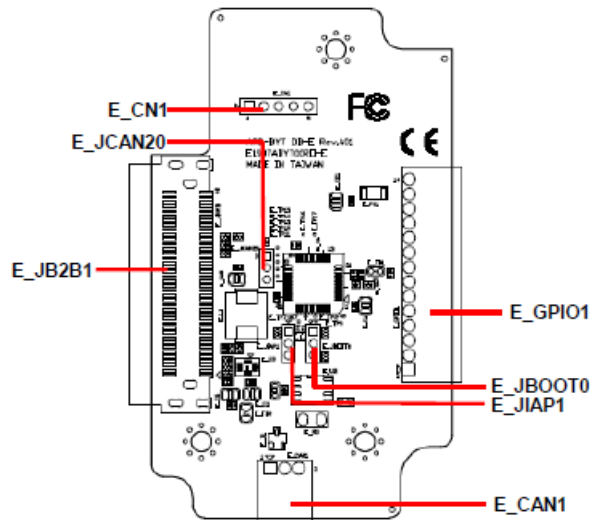

2.7.6 ARC-BYT DB-F

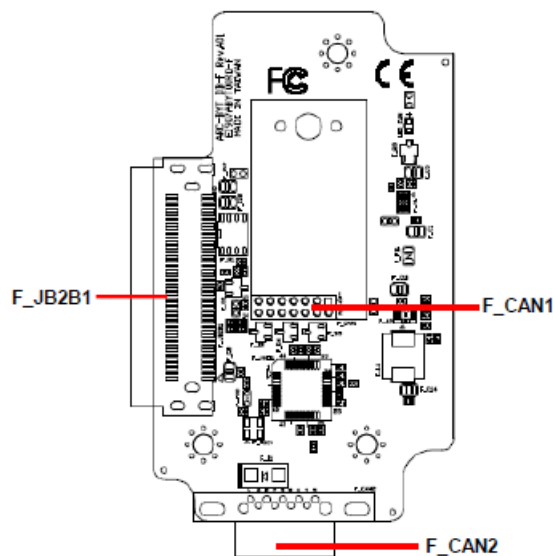

ARC-1732

2.7.7 ARC-BYT DB-G

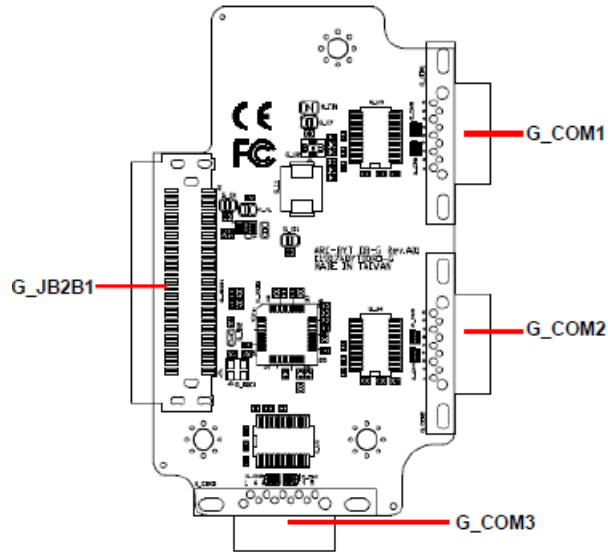

2.7.8 ARC-BYT DB-H

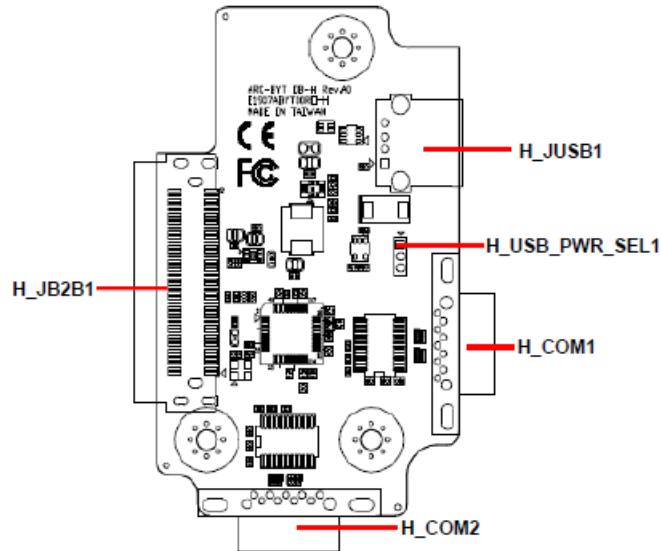

2.7.9 ARC-BYT DB-K

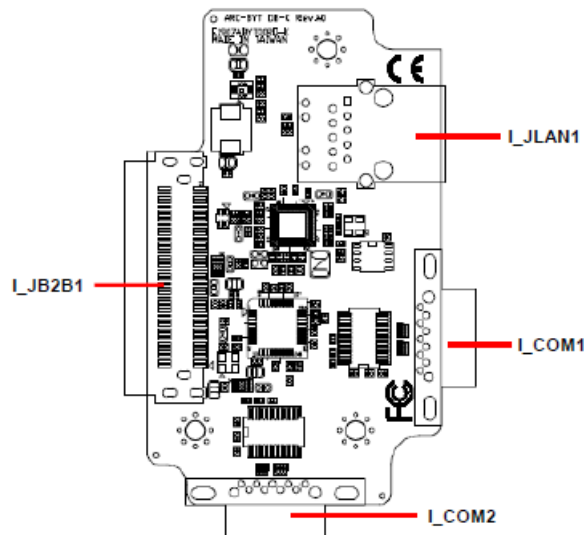

2.8 ARC-BYT DB-A/B/C/D/E/F/G/H/K Connector list

2.8.1 ARC-BYT DB-A

Connectors

Label	Function	Note
A_JUSB1~4	USB3.0 connector 1~4	
A_JB2B1	B2B connector	

2.8.2 ARC-BYT DB-B

Connectors

Label	Function	Note
B_LINE_OUT1	Line-out audio jack	
B_LINE_IN1	Line-in audio jack	
B_MIC_IN1	Mic-in audio jack	
B_JHDMI1	HDMI connector	
B_JB2B1	B2B connector	

2.8.3 ARC-BYT DB-C

Connectors

Label	Function	Note
C_JPCIE1	Mini PCI Express connector	
C_JSIM1	SIM card slot (Push-push)	
C_JHDMI1	HDMI connector	
C_JB2B1	B2B connector	

2.8.4 ARC-BYT DB-D

Connectors

Label	Function	Note
D_COM1/2	Serial Port 1/2 connector	DB-9 male connector
D_JB2B1	B2B connector	

2.8.5 ARC-BYT DB-E

Jumpers

Label	Function	Note
E_JCAN20	CAN2.0 Switch	3 x 1 header, pitch 2.00mm
E_JIAP1	For user update FW	3 x 1 header, pitch 2.00mm

ARC-1732

E_JBOOT0	For user update FW	3 x 1 header, pitch 2.00mm
-----------------	--------------------	----------------------------

Connectors

Label	Function	Note
E_GPIO1	General purpose I/O connector	14 x 1 terminal, pitch 2.50mm
E_CN1	For user update FW	5 x 1 header, pitch 2.54mm
E_CAN1	CAN Bus connector	3 x 1 terminal, pitch 2.50mm
E_JB2B1	B2B connector	

2.8.6 ARC-BYT DB-F

Connectors

Label	Function	Note
F_CAN1	CAN Bus connector 1	7 x 2 header, pitch 2.00mm
F_CAN2	CAN Bus connector 2	
F_JB2B1	B2B connector	

2.8.7 ARC-BYT DB-G

Connectors

Label	Function	Note
G_COM1/2/3	Serial Port 1/2/3 connector	DB-9 male connector
G_JB2B1	B2B connector	

2.8.8 ARC-BYT DB-H

Jumpers

Label	Function	Note
H_USB_PWR_SEL1	USB Power selector	3 x 1 header, pitch 2.00mm

Connectors

Label	Function	Note
H_JUSB1	USB3.0 connector	
H_COM1/2	Serial Port 1/2 connector	DB-9 male connector
H_JB2B1	B2B connector	

2.8.9 ARC-BYT DB-K

Connectors

Label	Function	Note
-------	----------	------

I_JLAN1	RJ-45 Ethernet	
I_COM1/2	Serial Port 1/2 connector	DB-9 male connector
I_JB2B1	B2B connector	

2.9 ARC-BYT DB-D Connectors settings

2.9.1 Serial Port 1 connector (D_COM1)

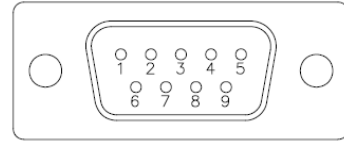
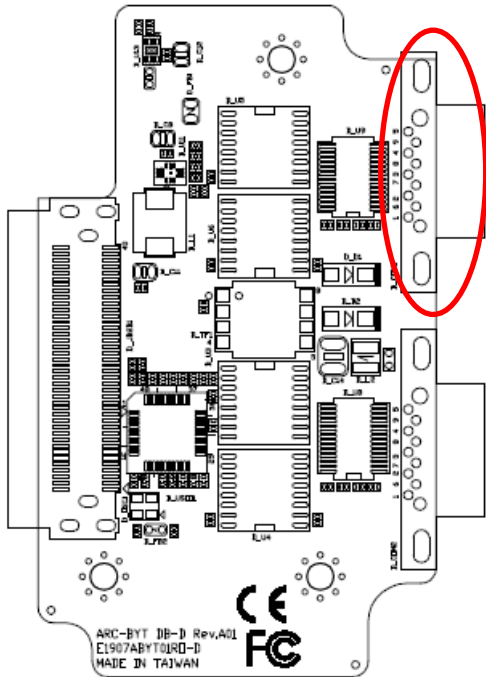

Signal	PIN	PIN	Signal
NDCD#_3_D	1	6	NDSR#_3_D
NRXD_3_D	2	7	NRTS#_3_D
NTXD_3_D	3	8	NCTS#_3_D
NDTR#_3_D	4	9	NRI#_3_D
GND	5		

2.9.2 Serial Port 2 connector (D_COM2)

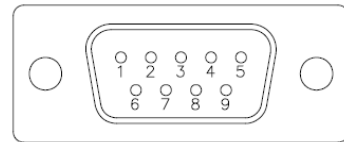
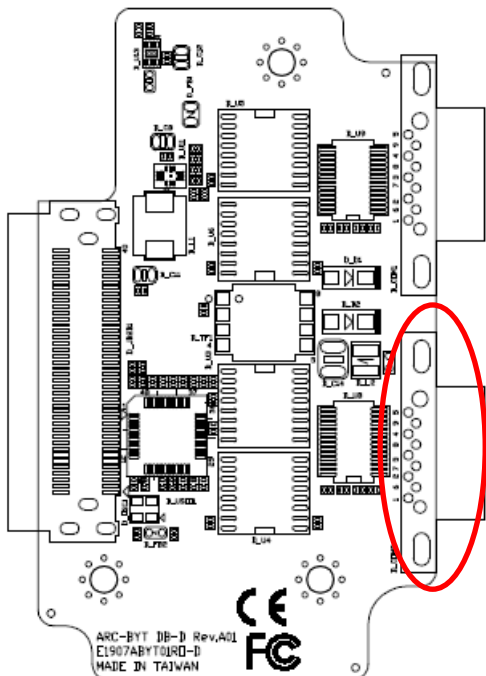

Signal	PIN	PIN	Signal
NDCD#_2_D	1	6	NDSR#_2_D
NRXD_2_D	2	7	NRTS#_2_D
NTXD_2_D	3	8	NCTS#_2_D
NDTR#_2_D	4	9	NRI#_2_D
GND	5		

2.10 ARC-BYT DB-E Jumpers & Connectors settings

2.10.1 CAN2.0 Switch (E_JCAN20)

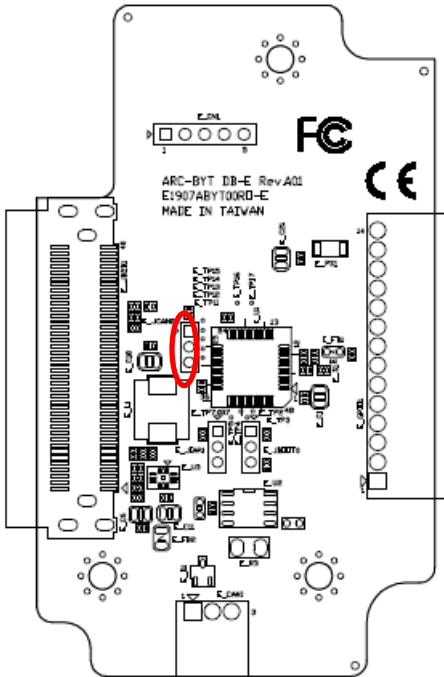

CAN2.0A (11-bit)*

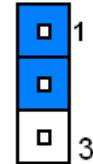

CAN2.0B (29-bit)

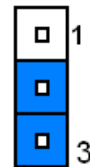

*Default

2.10.2 For user update FW (E_JBOOT0)

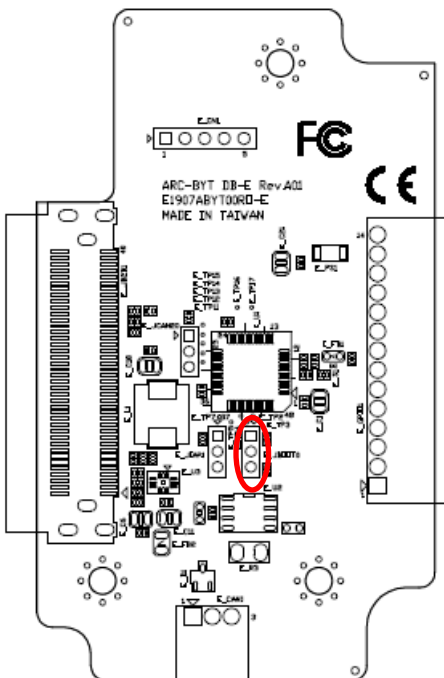

Default*

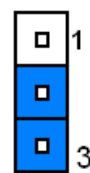

For user update FW

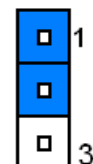

*Default

2.10.3 For user update FW (E_JIAP1)

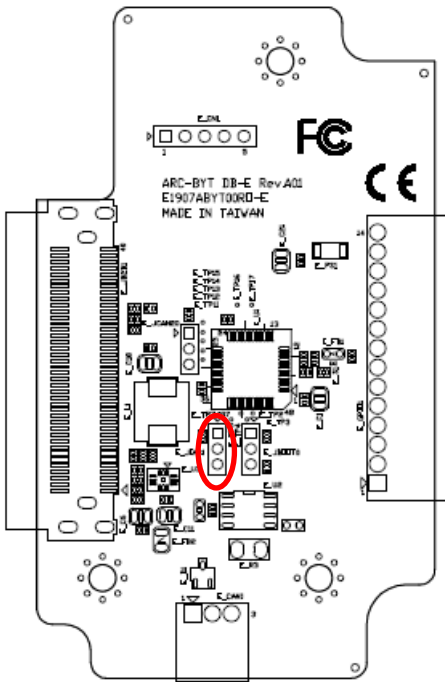

Default*

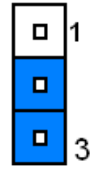

For user update FW

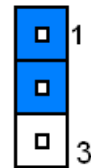

*Default

2.10.4 For user update FW (E_CN1)

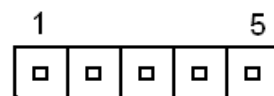
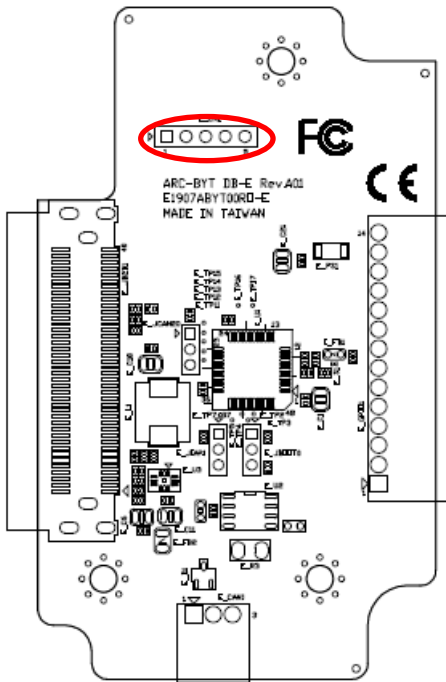

Signal	PIN
+3.3V	1
SWDIO	2
SWCLK	3
CAN_BUS_RESET#	4
GND	5

2.10.5 General purpose I/O connector (E_GPIO1)

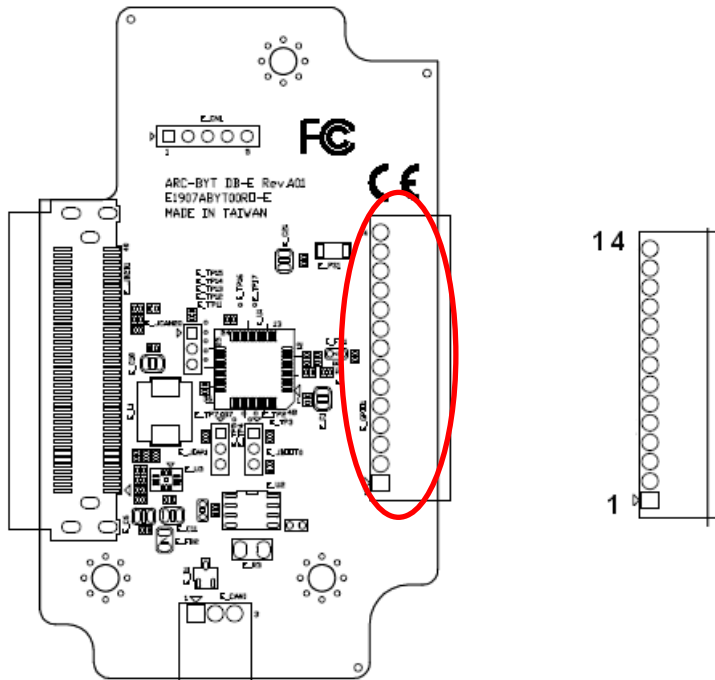

Signal	PIN
GND	14
+3.3V	13
DO5	12
DO4	11
DO3	10
DO2	9
DO1	8
DO0	7
DI5	6
DI4	5
DI3	4
DI2	3
DI1	2
DI0	1

2.10.6 CAN Bus connector (E_CAN1)

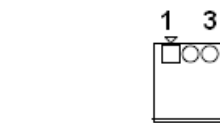
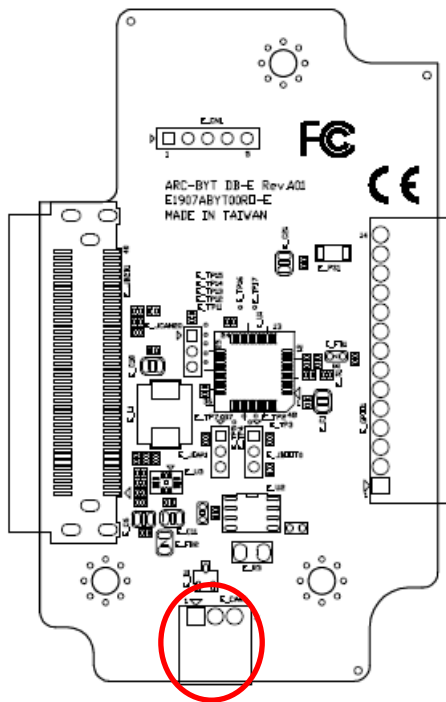

Signal	PIN
CANH	1
CANL	2
GND	3

2.11 ARC-BYT DB-F Connectors settings

2.11.1 CAN Bus connector 1 (F_CAN1)

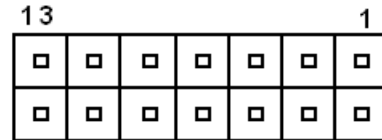
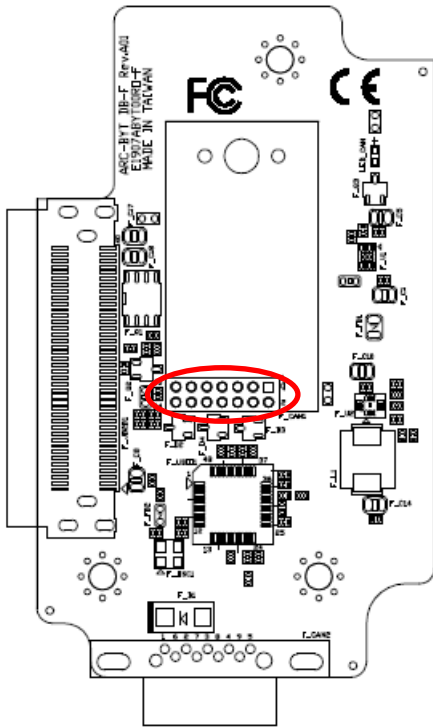

Signal	PIN	PIN	Signal
CAN_PWR	1	2	CAN_8
CAN_IND	3	4	CAN_9
GND	5	6	BAT_GND
CAN_WAKE	7	8	CAN_11
UART_RXD_1_F	9	10	CAN_12
UART_TXD_1_F	11	12	CAN_13
+5V	13	14	CAN_14

2.11.2 CAN Bus connector 2 (F_CAN2)

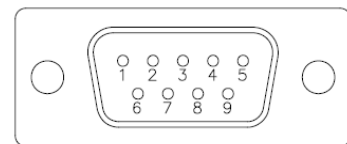
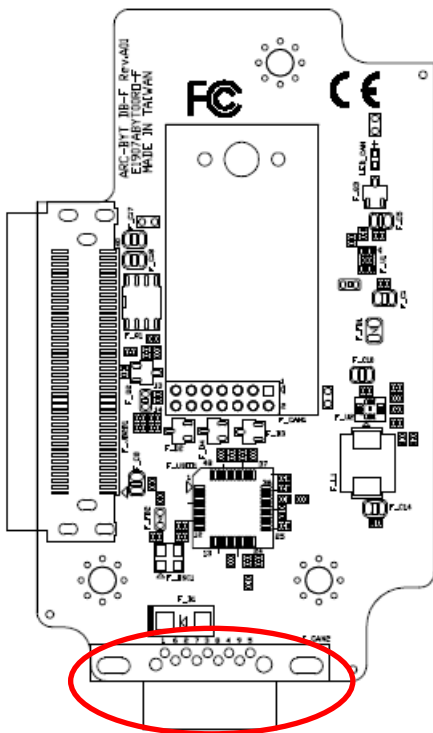

Signal	PIN	PIN	Signal
BAT_PWR	1	6	CAN_12
CAN_8	2	7	CAN_13
CAN_9	3	8	CAN_14
BAT_GND	4	9	NC
CAN_11	5		

2.12 ARC-BYT DB-G Connectors settings

2.12.1 Serial Port 1 connector (G_COM1)

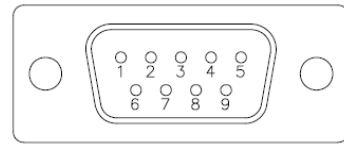
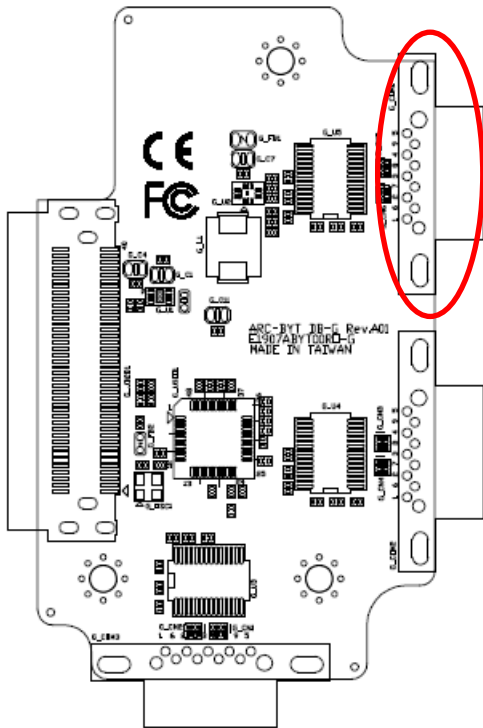

Signal	PIN	PIN	Signal
NDCD#_3_G	1	6	NDSR#_3_G
NRXD_3_G	2	7	NRTS#_3_G
NTXD_3_G	3	8	NCTS#_3_G
NDTR#_3_G	4	9	NRI#_3_G
GND	5		

2.12.2 Serial Port 2 connector (G_COM2)

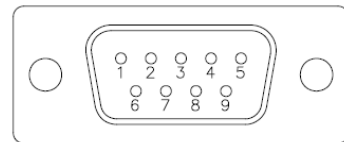
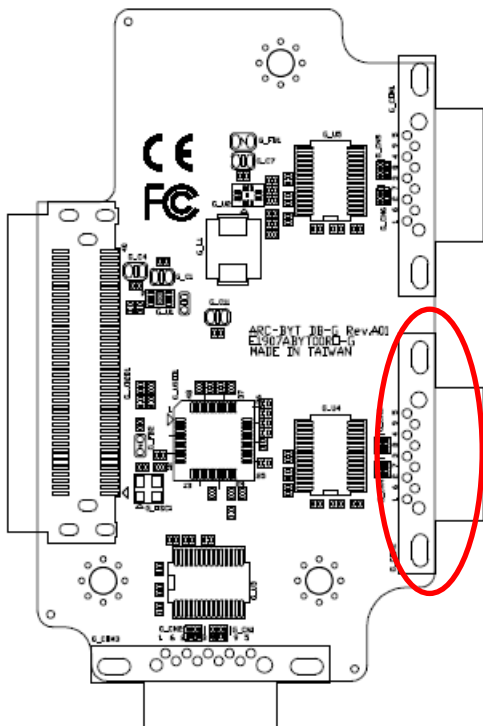

Signal	PIN	PIN	Signal
NDCD#_2_G	1	6	NDSR#_2_G
NRXD_2_G	2	7	NRTS#_2_G
NTXD_2_G	3	8	NCTS#_2_G
NDTR#_2_G	4	9	NRI#_2_G
GND	5		

ARC-1732

2.12.3 Serial Port 3 connector (G_COM3)

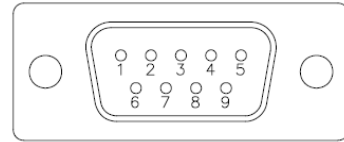
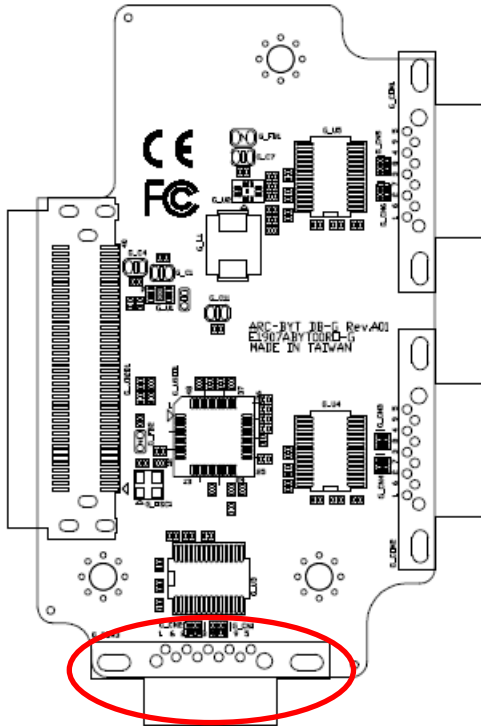

Signal	PIN	PIN	Signal
NDCD#_1_G	1	6	NDSR#_1_G
NRXD_1_G	2	7	NRTS#_1_G
NTXD_1_G	3	8	NCTS#_1_G
NDTR#_1_G	4	9	NRI#_1_G
GND	5		

2.13 ARC-BYT DB-H Jumpers settings

2.13.1 USB Power selector (H_USB_PWR_SEL1)

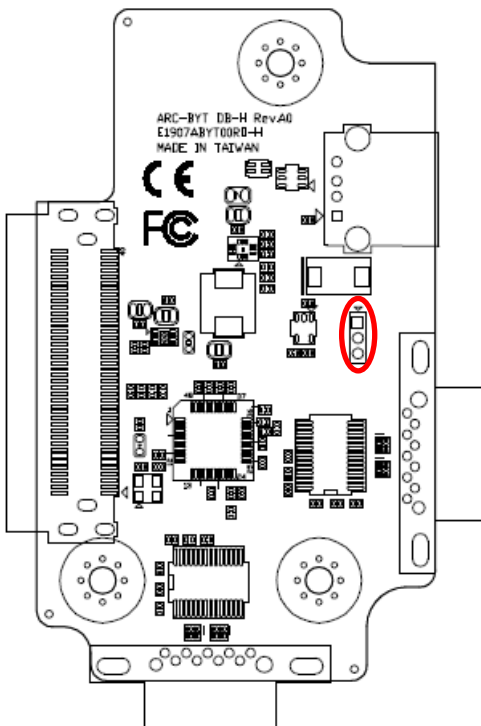

+5VSB*

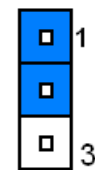

+5V

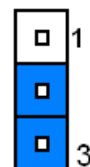

*Default

2.14 ARC-BYT DB-H Connectors settings

2.14.1 Serial Port 1 connector (H_COM1)

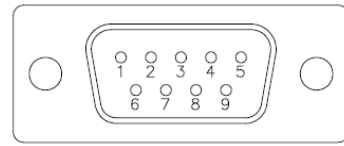
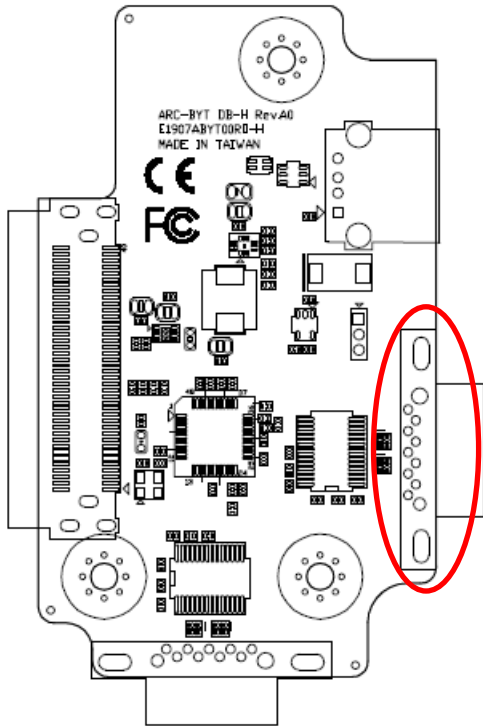

Signal	PIN	PIN	Signal
NDCD#_1_H	1	6	NDSR#_1_H
NRXD_1_H	2	7	NRTS#_1_H
NTXD_1_H	3	8	NCTS#_1_H
NDTR#_1_H	4	9	NRI#_1_H
GND	5		

2.14.2 Serial Port 2 connector (H_COM2)

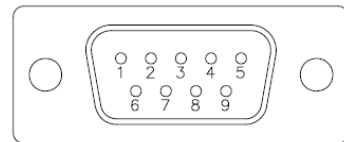
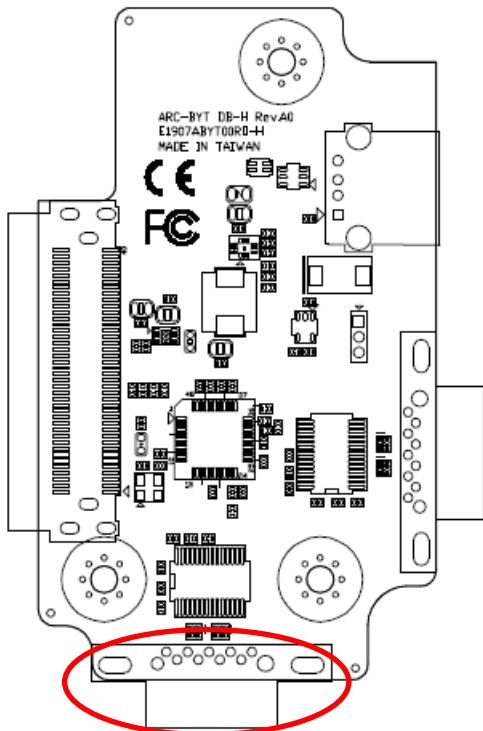

Signal	PIN	PIN	Signal
NDCD#_2_H	1	6	NDSR#_2_H
NRXD_2_H	2	7	NRTS#_2_H
NTXD_2_H	3	8	NCTS#_2_H
NDTR#_2_H	4	9	NRI#_2_H
GND	5		

2.15 ARC-BYT DB-K Connectors settings

2.15.1 Serial Port 1 connector (I_COM1)

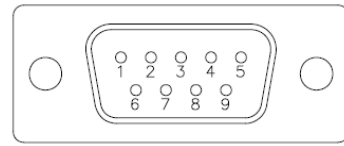
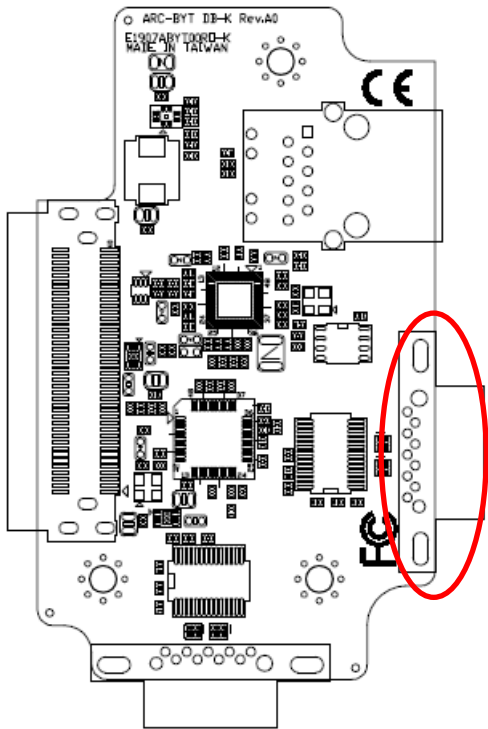

Signal	PIN	PIN	Signal
NDCD#_1_I	1	6	NDSR#_1_I
NRXD_1_I	2	7	NRTS#_1_I
NTXD_1_I	3	8	NCTS#_1_I
NDTR#_1_I	4	9	NRI#_1_I
GND	5		

2.15.2 Serial Port 2 connector (I_COM2)

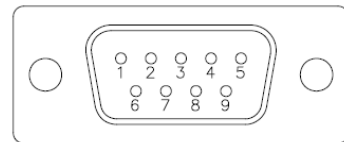
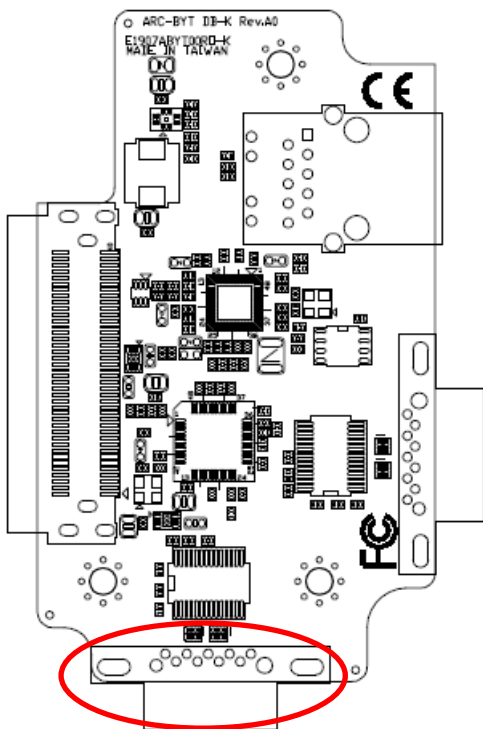

Signal	PIN	PIN	Signal
NDCD#_2_I	1	6	NDSR#_2_I
NRXD_2_I	2	7	NRTS#_2_I
NTXD_2_I	3	8	NCTS#_2_I
NDTR#_2_I	4	9	NRI#_2_I
GND	5		

3. BIOS Setup

3.1 Introduction

The BIOS setup program allows users to modify the basic system configuration. In this following chapter will describe how to access the BIOS setup program and the configuration options that may be changed.

3.2 Starting Setup

AMI BIOS™ is immediately activated when you first power on the computer. The BIOS reads the system information contained in the NVRAM and begins the process of checking out the system and configuring it. When it finishes, the BIOS will seek an operating system on one of the disks and then launch and turn control over to the operating system.

While the BIOS is in control, the Setup program can be activated in one of two ways:

By pressing <F2> or immediately after switching the system on, or

By pressing the <F2> or key when the following message appears briefly at the left-top of the screen during the POST (Power On Self Test).

Press <F2> or to enter SETUP

If the message disappears before you respond and you still wish to enter Setup, restart the system to try again by turning it OFF then ON or pressing the "RESET" button on the system case. You may also restart by simultaneously pressing <Ctrl>, <Alt>, and <Delete> keys.

3.3 Using Setup

In general, you use the arrow keys to highlight items, press <Enter> to select, use the PageUp and PageDown keys to change entries, press <F1> for help and press <Esc> to quit. The following table provides more detail about how to navigate in the Setup program using the keyboard.

Button	Description
↑	Move to previous item
↓	Move to next item
←	Move to the item in the left hand
→	Move to the item in the right hand
Esc key	Main Menu -- Quit and not save changes into NVRAM Status Page Setup Menu and Option Page Setup Menu -- Exit current page and return to Main Menu
+ key	Increase the numeric value or make changes
- key	Decrease the numeric value or make changes
F1 key	General help, only for Status Page Setup Menu and Option Page Setup Menu
F2 key	Previous Values
F3 key	Optimized defaults
F4 key	Save & Exit Setup

- **Navigating Through The Menu Bar**

Use the left and right arrow keys to choose the menu you want to be in.



Note: Some of the navigation keys differ from one screen to another.

- **To Display a Sub Menu**

Use the arrow keys to move the cursor to the sub menu you want. Then press <Enter>. A “➤” pointer marks all sub menus.

3.4 Getting Help

Press F1 to pop up a small help window that describes the appropriate keys to use and the possible selections for the highlighted item. To exit the Help Window press <Esc> or the F1 key again.

3.5 In Case of Problems

If, after making and saving system changes with Setup, you discover that your computer no longer is able to boot, the AMI BIOS supports an override to the NVRAM settings which resets your system to its defaults.

The best advice is to only alter settings which you thoroughly understand. To this end, we strongly recommend that you avoid making any changes to the chipset defaults. These defaults have been carefully chosen by both BIOS Vendor and your systems manufacturer to provide the absolute maximum performance and reliability. Even a seemingly small change to the chipset setup has the potential for causing you to use the override.

3.6 BIOS setup

Once you enter the Aptio Setup Utility, the Main Menu will appear on the screen. The Main Menu allows you to select from several setup functions and exit choices. Use the arrow keys to select among the items and press <Enter> to accept and enter the sub-menu.

3.6.1 Main Menu

This section allows you to record some basic hardware configurations in your computer and set the system clock.

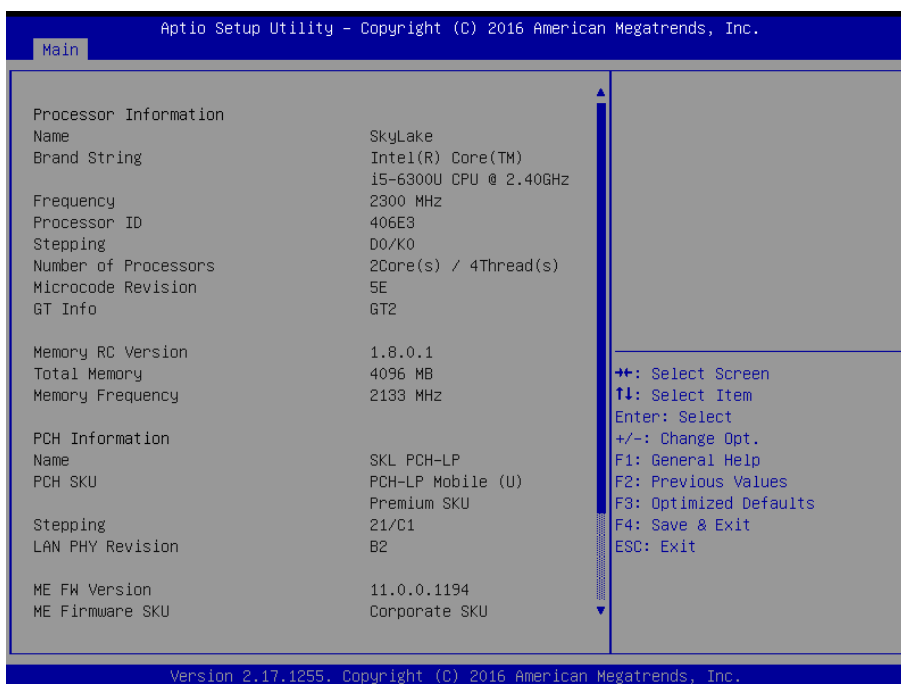

ARC-1732

3.6.1.1 System Language

This option allows choosing the system default language.

3.6.1.2 System Date

Use the system date option to set the system date. Manually enter the day, month and year.

3.6.1.3 System Time

Use the system time option to set the system time. Manually enter the hours, minutes and seconds.

3.6.2 Advanced Menu

This section allows you to configure your CPU and other system devices for basic operation through the following sub-menus.

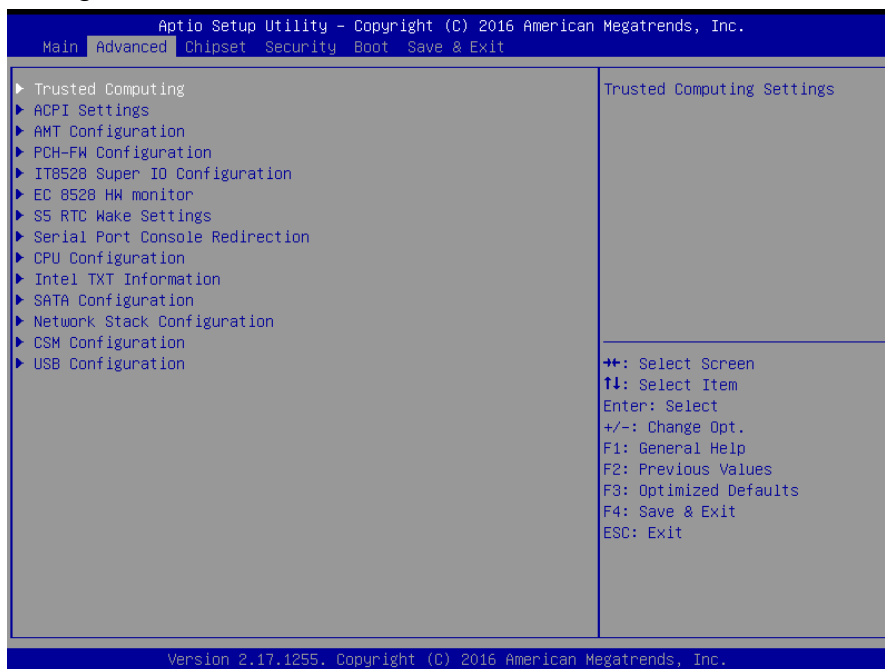

3.6.2.1 Trusted Computing

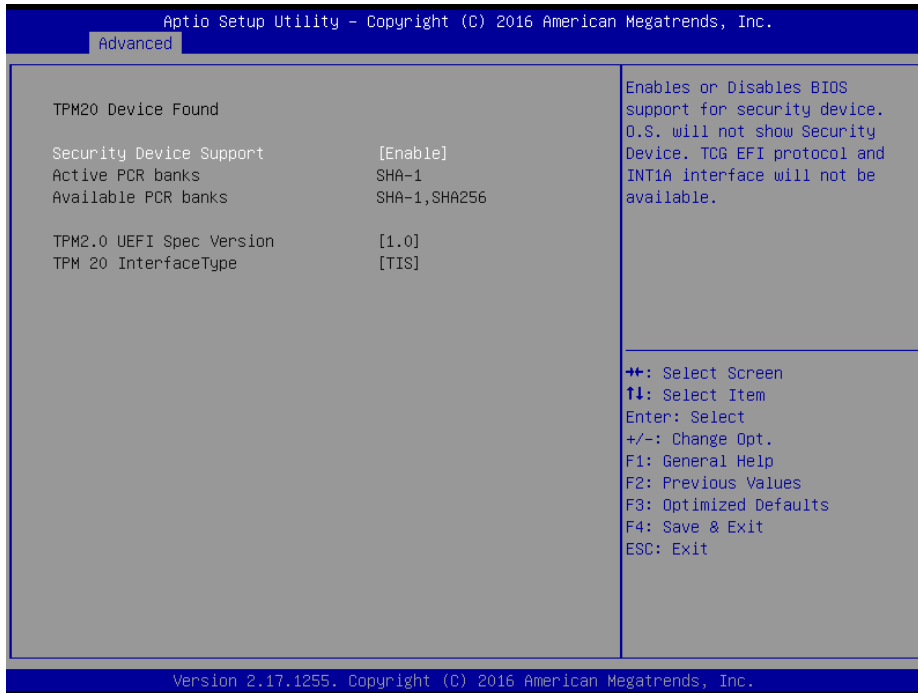

Item	Options	Description
Security Device Support	Disable, Enable[Default]	Enables or Disables BIOS support for security device. O.S. will not show Security Device. TCG EFI protocol and INT1A interface will not be available.

3.6.2.2 APCI Settings

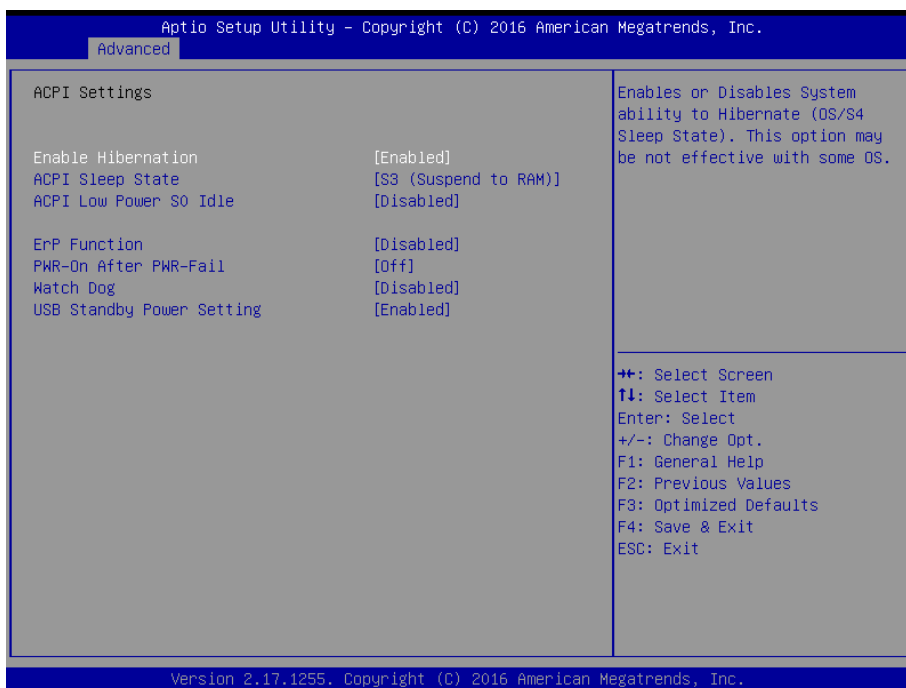

ARC-1732

Item	Options	Description
Enable Hibernation	Disabled Enabled[Default],	Enables or Disables System ability to Hibernate (OS/S4 Sleep State). This option may be not effective with some OS.
ACPI Sleep State	Suspend Disabled, S3 (Suspend to RAM) [Default]	Select the highest ACPI sleep state the system will enter when the SUSPEND button is pressed.
ACPI Low Power S0 Idle	Disabled[Default], Enabled	Enable or Disable ACPI Low Power S0 Idle Support.
ErP Function	Disabled[Default], Enabled	ErP Function (Deep S5).
PWR-On After PWR-Fail	Off[Default] On Last state	AC loss resume.
Watch Dog	Disabled[Default], 30 sec 40 sec 50 sec 1 min 2 min 10 min 30 min	Select WatchDog.
USB Standby Power Setting	Disabled Enabled[Default],	Enabled/Disabled USB Standby Power during S3/S4/S5.

3.6.2.3 AMT Configuration



Item	Options	Description
Intel AMT	Disabled Enabled[Default],	Enable/Disable Intel® Active Management Technology BIOS Extension. Note: iAMT H/W is always enabled. This option just controls the BIOS extension execution. If enabled, this requires additional firmware in the SPI device.
Un-Configure ME	Disabled[Default] Enabled,	OEMFlag Bit 15: Un-Configure ME without password.

3.6.2.4 PCH-FW Configuration

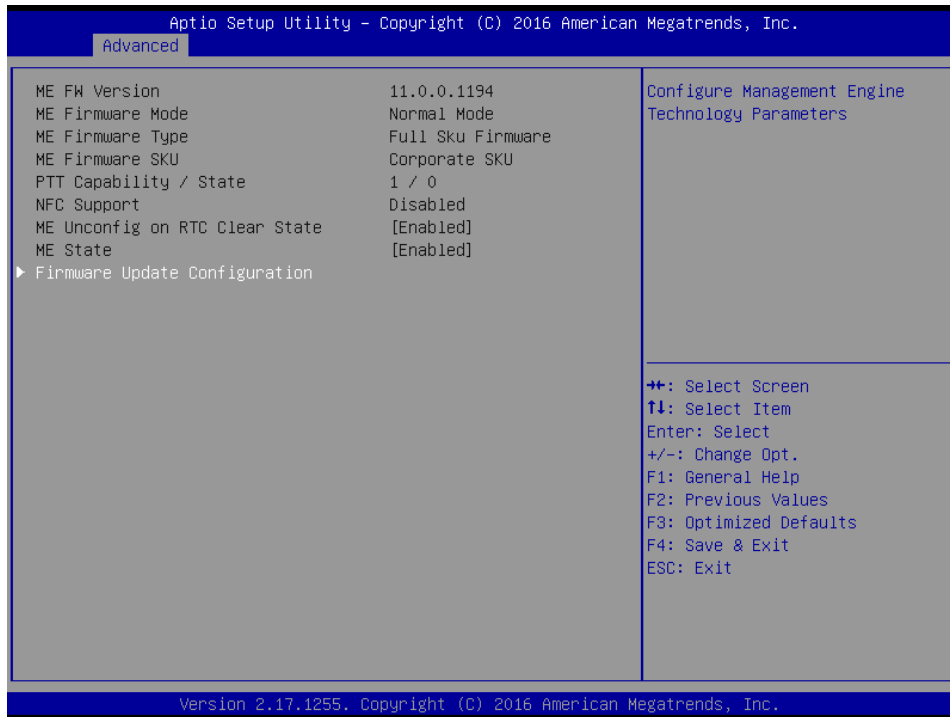

3.6.2.5 IT8528 Super IO Configuration

You can use this item to set up or change the IT8528 Super IO configuration for serial ports. Please refer to 3.6.2.5.1~ 3.6.2.5.5 for more information.

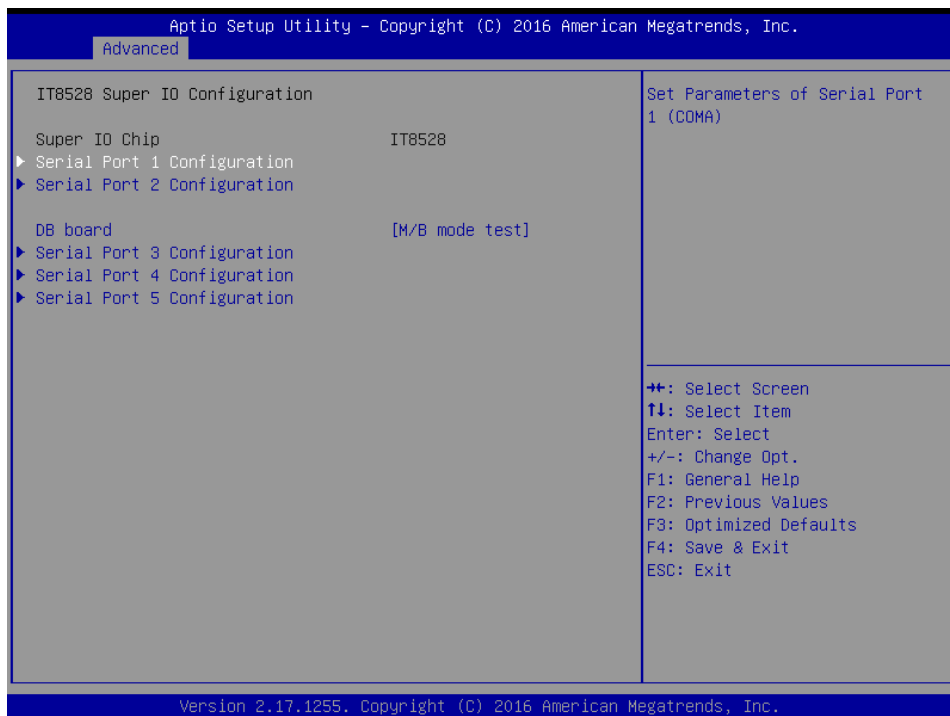

Item	Options	Description
DB board	DB-A/C/E/J DB-B DB-F 1COM	DB board A-K. DA-A/B/C/E/J w/o UART DB-G w/t 3UART DB-D/H/K w/t 2UART DB-F w/t 1UART.

	DB-D/H/K 2COM DB-G 3COM M/B mode test[Default],
Serial Port 1 Configuration	Set Parameters of Serial Port 1 (COMA).
Serial Port 2 Configuration	Set Parameters of Serial Port 2 (COMB).
Serial Port 3 Configuration	Set Parameters of Serial Port 3 (COMC).
Serial Port 4 Configuration	Set Parameters of Serial Port 4 (COMD).
Serial Port 5 Configuration	Set Parameters of Serial Port 5 (COME).

3.6.2.5.1 Serial Port 1 Configuration

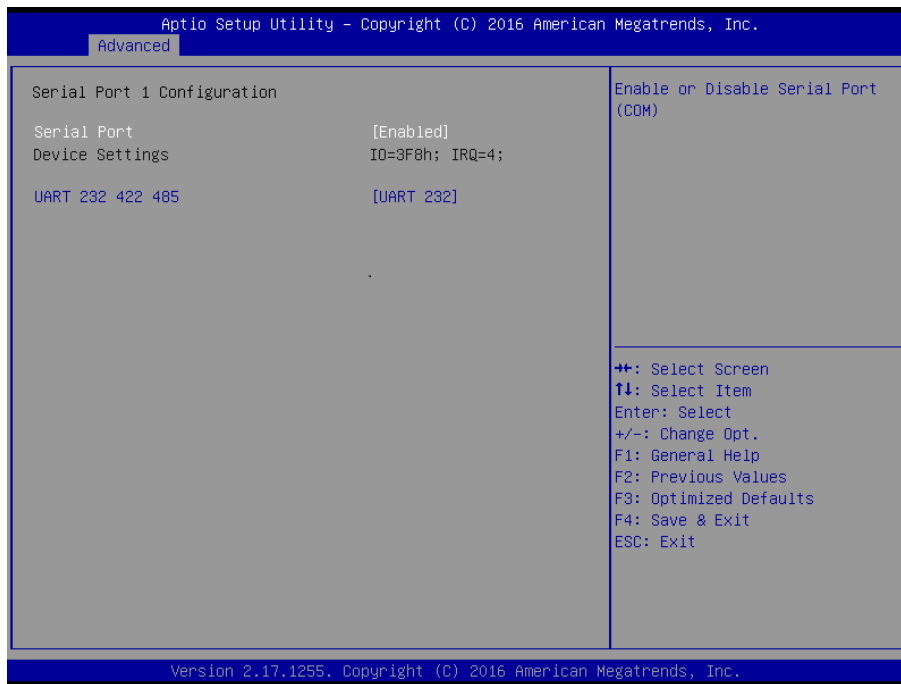

Item	Option	Description
Serial Port	Enabled[Default], Disabled	Enable or Disable Serial Port (COM).
UART 232 422 485	UART 232[Default] UART 422 UART 485	Change the Serial Port

3.6.2.5.2 Serial Port 2 Configuration



Item	Option	Description
Serial Port	Enabled[Default], Disabled	Enable or Disable Serial Port (COM).

3.6.2.5.3 Serial Port 3 Configuration

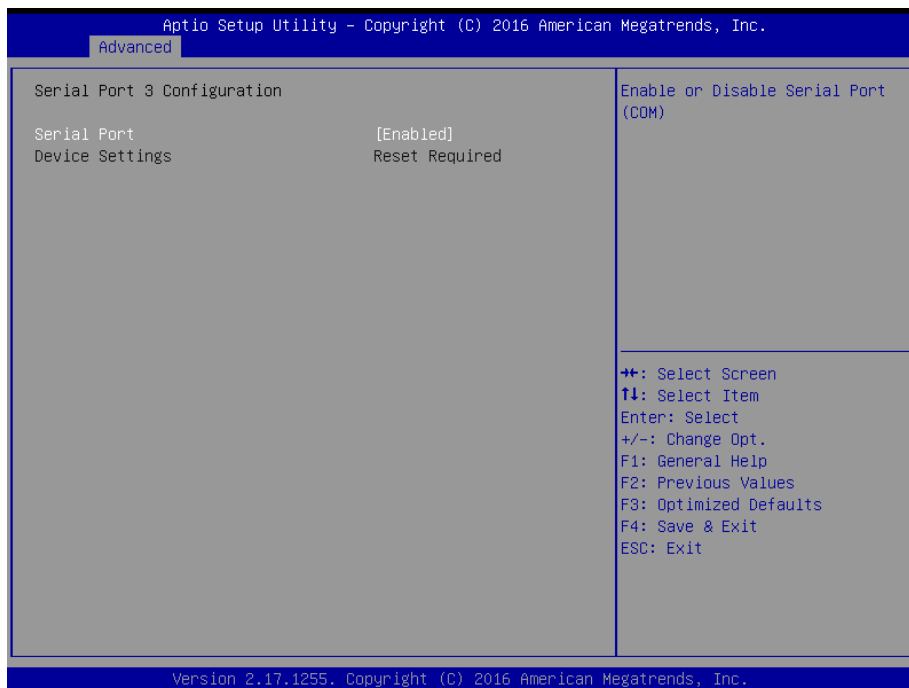

Item	Option	Description
Serial Port	Enabled[Default], Disabled	Enable or Disable Serial Port (COM).

3.6.2.5.4 Serial Port 4 Configuration

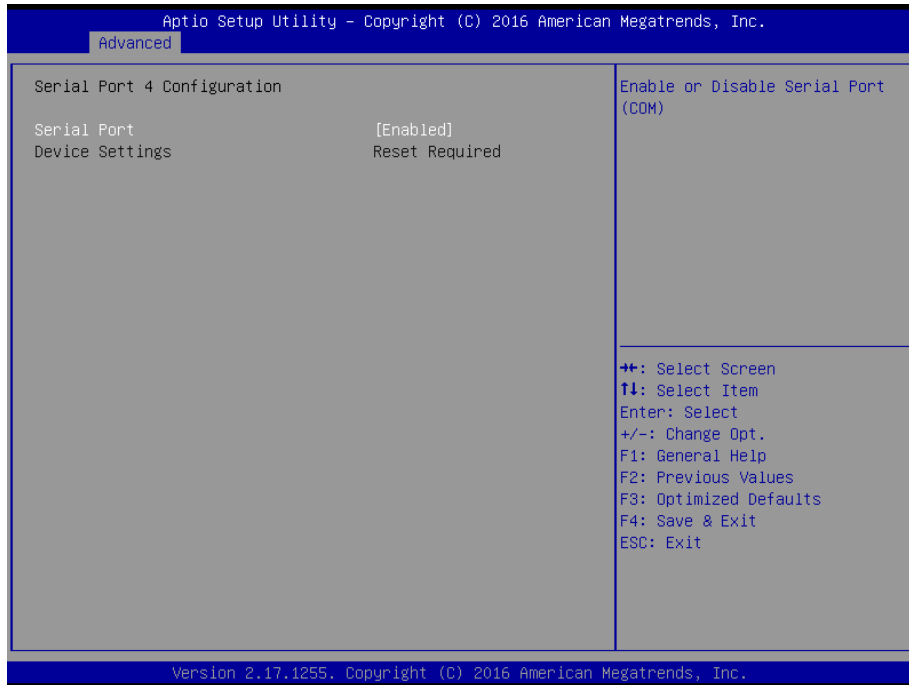

Item	Option	Description
Serial Port	Enabled[Default], Disabled	Enable or Disable Serial Port (COM).

3.6.2.5.5 Serial Port 5 Configuration

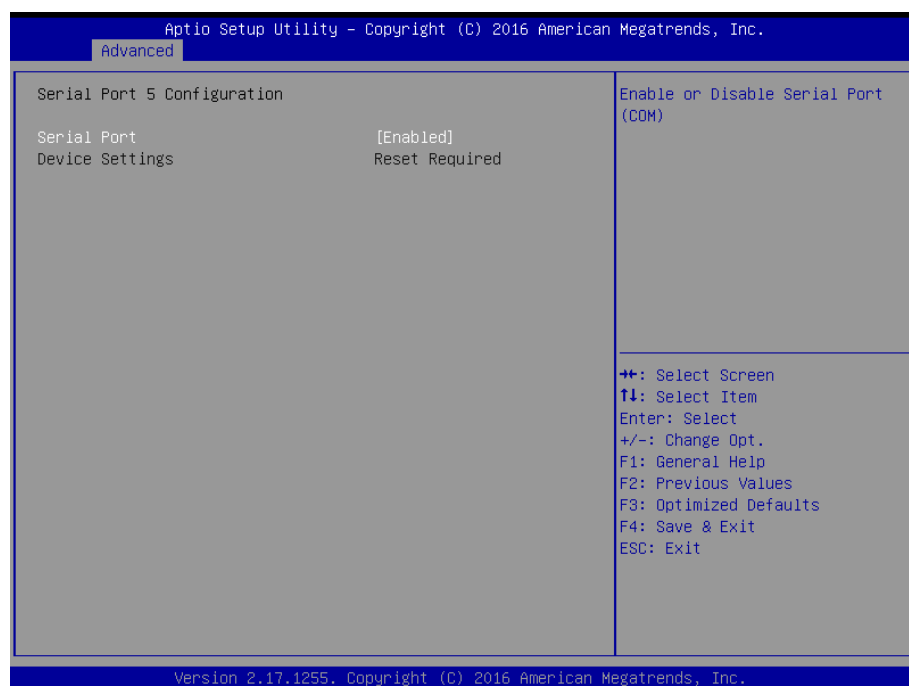

Item	Option	Description
Serial Port	Enabled[Default], Disabled	Enable or Disable Serial Port (COM).

3.6.2.6 H/W Monitor

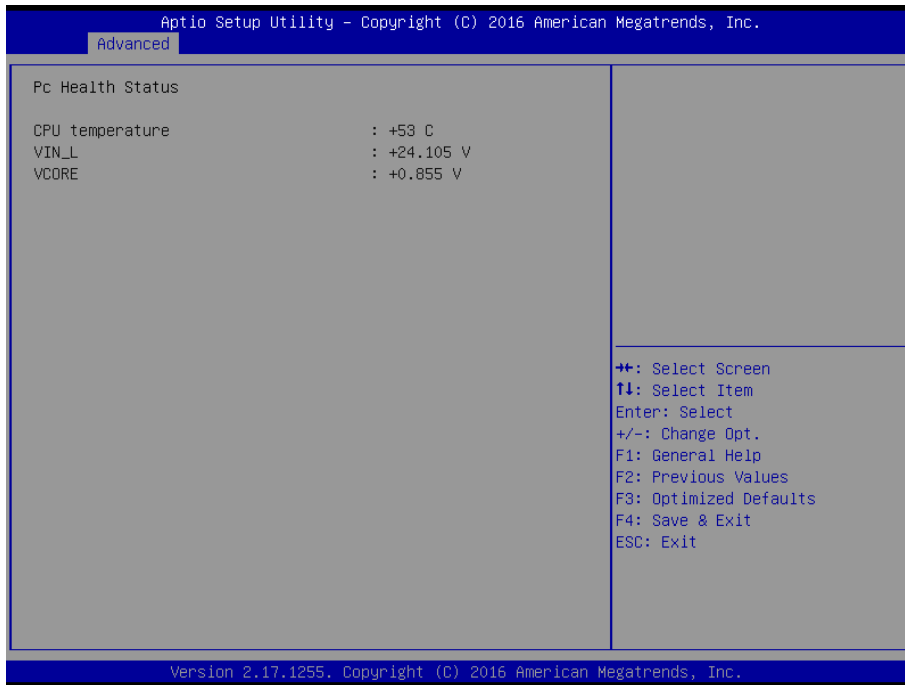

3.6.2.7 S5 RTC Wake Settings

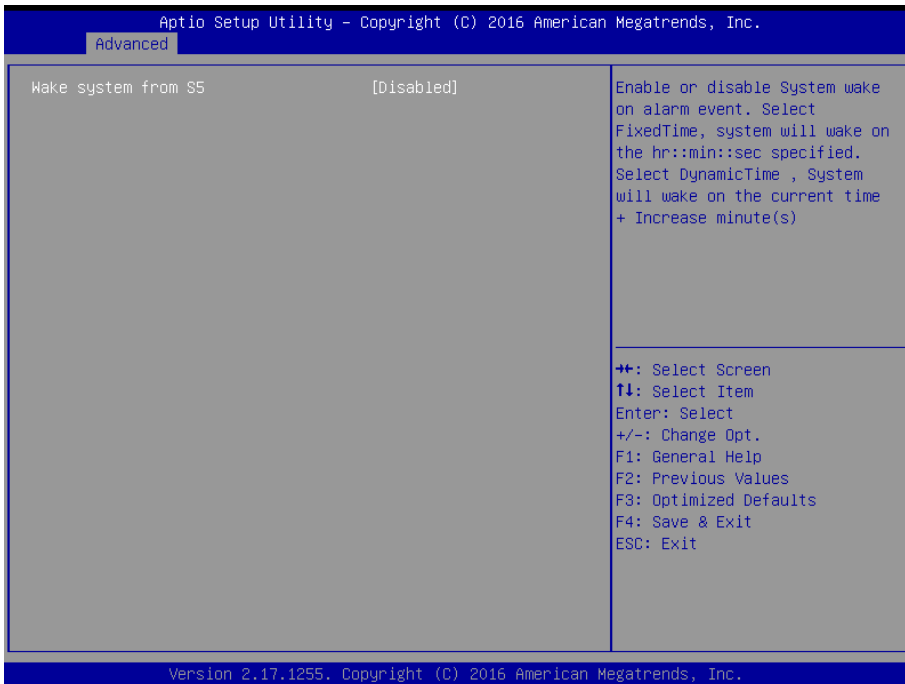

Item	Options	Description
Wake system from S5	Disabled[Default], Fixed Time Dynamic Time	Enable or disable System wake on alarm event. Select Fixed Time, system will wake on the hr::min::sec specified. Select Dynamic Time, System will wake on the current time + Increase minute(s).

3.6.2.8 Serial Port Console Redirection

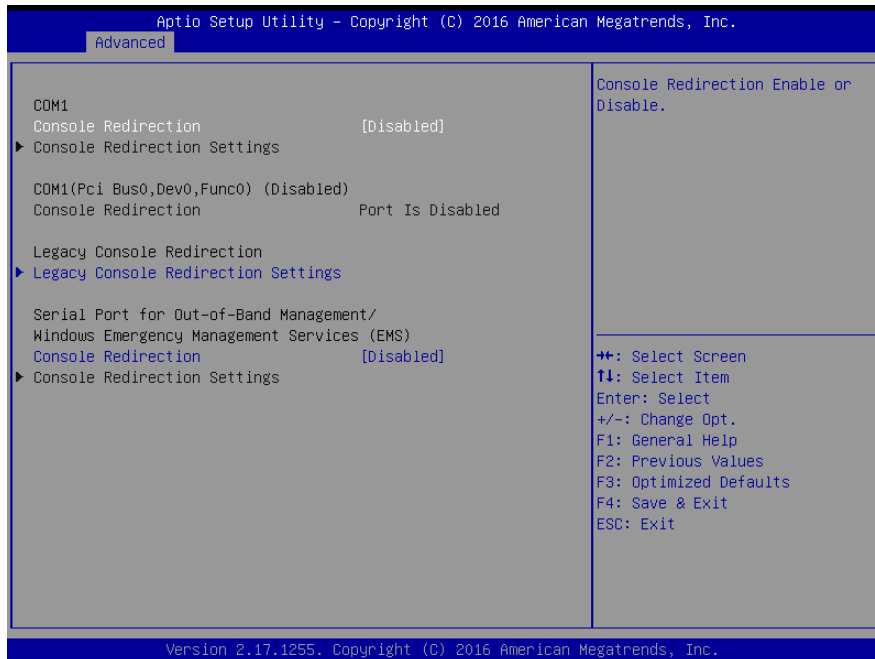

Item	Options	Description
Console Redirection	Disabled[Default], Enabled	Console Redirection Enable or Disable.

3.6.2.8.1 Legacy Console Redirection Settings

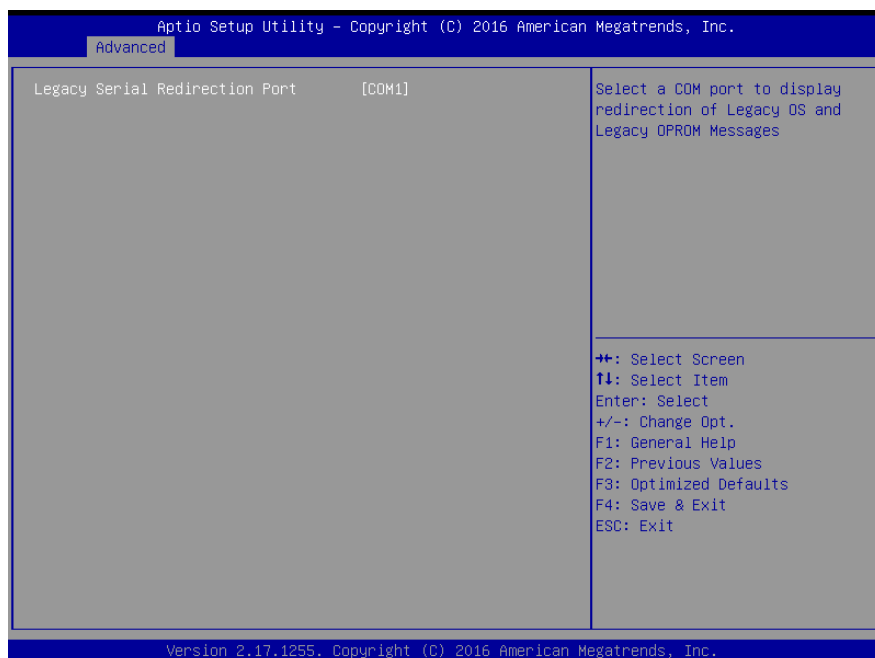

Item	Option	Description
Legacy Serial Redirection Port	COM1[Default],	Select a COM port to display redirection of Legacy OS and Legacy OPROM Messages.

3.6.2.9 CPU Configuration

Use the CPU configuration menu to view detailed CPU specification and configure the CPU.

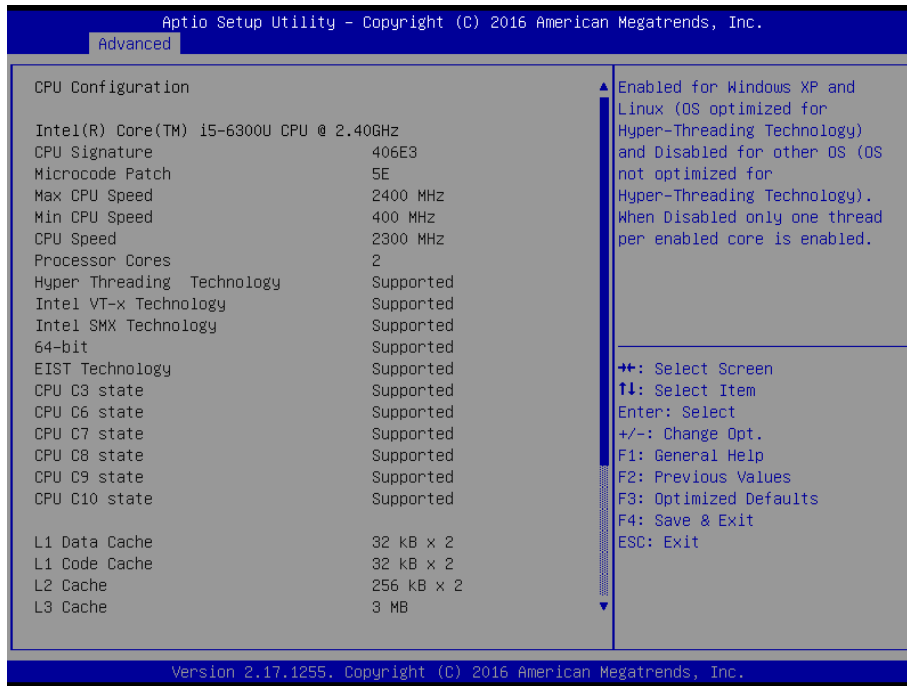

3.6.2.10 Intel TXT Configuration

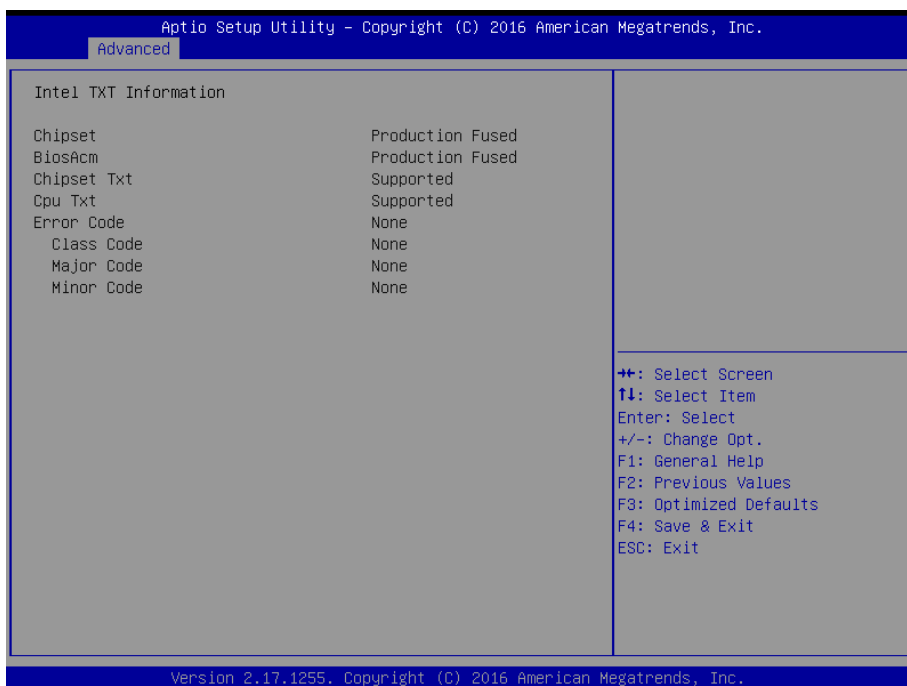

3.6.2.11 SATA Configuration

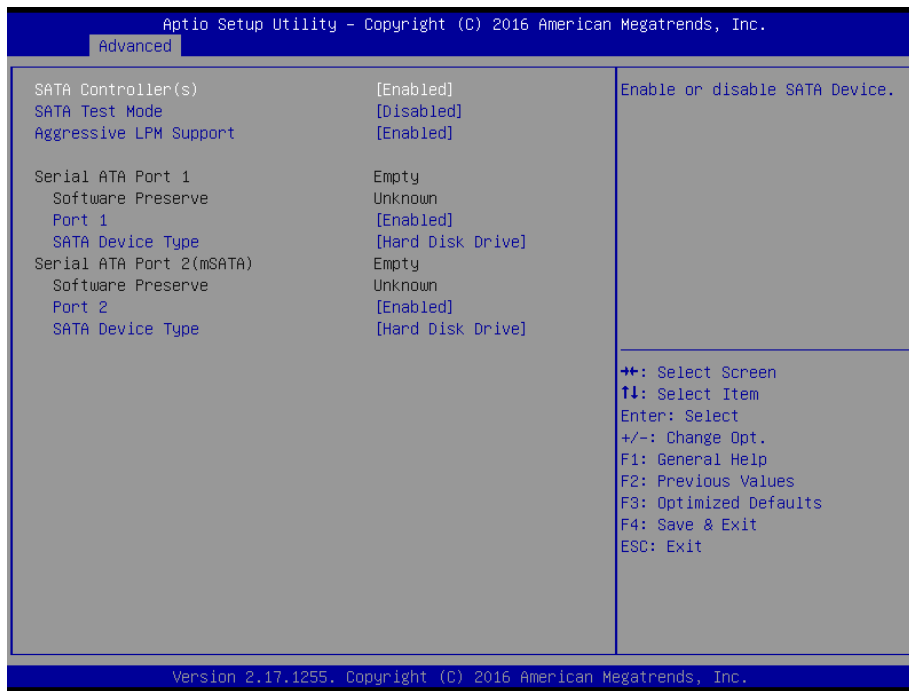

Item	Options	Description
SATA Controller(s)	Enabled[Default] Disabled,	Enable or disable SATA Device.
SATA Test Mode	Enabled Disabled[Default],	Test Mode Enable/Disable (Loop Back).
Aggressive LPM Support	Enabled[Default] Disabled	Enable PCH to aggressively enter link power state.
Port 1/2	Enabled[Default] Disabled,	Enable or Disable SATA Port.
SATA Device Type	Hard Disk Drive [Default] Solid State Drive	Identify the SATA port is connected to Solid State Drive or Hard Disk Drive.

3.6.2.12 Network Stack Configuration

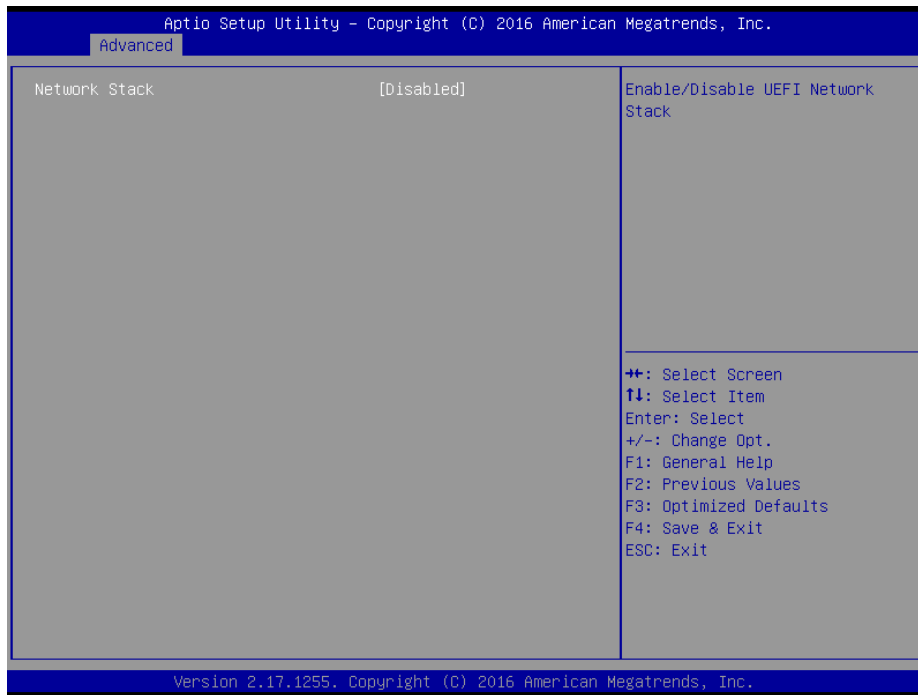

Item	Options	Description
Network Stack	Enabled Disabled[Default]	Enable/Disable UEFI Network Stack.

3.6.2.13 CSM Configuration



Item	Options	Description
CSM Support	Enabled Disabled[Default]	Enable/Disable CSM Support.

3.6.2.14 USB Configuration

The USB Configuration menu helps read USB information and configures USB settings.

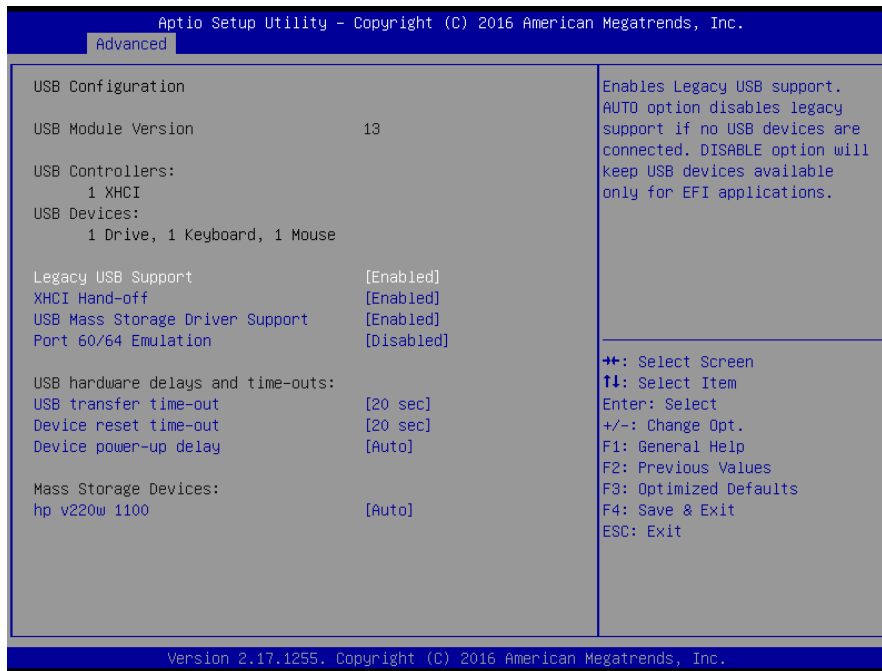

Item	Options	Description
Legacy USB Support	Enabled[Default] Disabled Auto	Enables Legacy USB support. AUTO option disables legacy support if no USB devices are connected. DISABLE option will keep USB devices available only for EFI applications.
XHCI Hand-off	Enabled[Default] Disabled	This is a workaround for OSES without XHCI hand-off support. The XHCI ownership change should be claimed by XHCI driver.
USB Mass Storage Driver Support	Enabled[Default] Disabled	Enable/Disable USB Mass Storage Driver Support.
Port 60/64 Emulation	Enabled Disabled[Default]	Enable I/O port 60h/64h emulation support. This should be enabled for the complete USB keyboard legacy support for non-USB aware OSES.
USB transfer time-out	1 sec 5 sec 10 sec 20 sec[Default]	The time-out value for Control, Bulk, and Interrupt transfers.
Device reset time-out	10 sec 20 sec[Default] 30 sec 40 sec	USB mass storage device Start Unit command time-out.
Device power-up delay	Auto[Default]	Maximum time the device will take before it

	Manual	properly reports itself to the Host Controller. 'Auto' uses default value: for a Root port it is 100ms, for a Hub port the delay is taken form Hub descriptor.
hp v220w 1100	Auto[Default] Floppy Forced FDD Hard Disk CD-ROM	Mass storage device emulation type. 'AUTO' enumerates devices according to their media format. Optical drives are emulated as 'CDROM', drives with no media will be emulated according to a drive type.

3.6.3 Chipset



3.6.3.1 System Agent (SA) Configuration



Item	Option	Description
VT-d	Enabled[Default] Disabled	VT-d capability.

3.6.3.1.1 Graphics Configuration

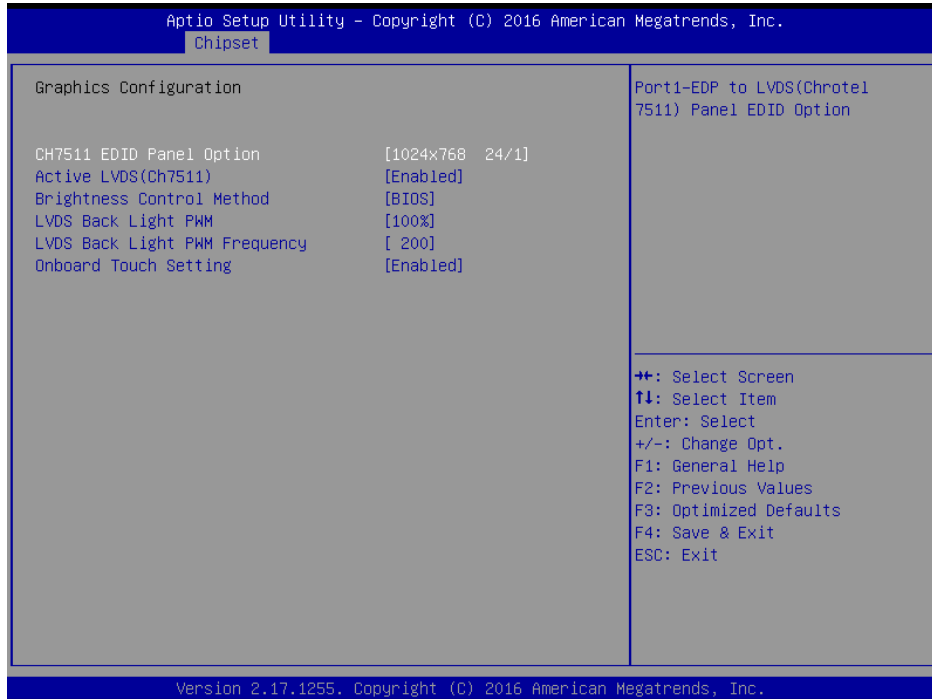

Item	Option	Description
CH7511 EDID Panel Option	1024x768 24/1 800x600 18/1 1024x768 18/1 1366x768 18/1 1024x600 18/1 1280x800 18/1 1920x1200 24/2 1920x1080 18/2 1280x1024 24/2[Default] 1440x900 18/2 1600x1200 24/2 1366x768 24/1 1920x1080 24/2 1680x1050 24/2	Port1-EDP to LVDS (Chrotel 7511) Panel EDID Option.
Active LVDS (CH7511)	Enabled[Default] Disabled	Active Internal LVDS (eDP->Ch7511-to-LVDS).
Brightness Control Method	BIOS[Default] BR Button VR OS Driver	LVDS Brightness Control Method. 1.BIOS 2.Brightness Button 3.Variable Resistor 4.OS Driver.
LVDS Back Light PWM	00% 25% 50%	Select LVDS back light PWM duty.

	75% 100% [Default]	
LVDS Back Light PWM Frequency	200 [Default] 300 400 500 700 1k 2k 3k 5k 10k 20k	Select LVDS back light PWM Frequency.
Onboard Touch Setting	Enabled [Default] Disabled	Enable/Disable USB Touch.

3.6.3.1.2 Memory Configuration



Item	Option	Description
Max TOLUD	Dynamic [Default] 1GB/1.25GB/1.5GB/1.75GB /2GB/2.25GB/2.5GB/2.75GB	Maximum Value of TOLUD. Dynamic assignment would adjust TOLUD automatically based on largest MMIO length of installed graphic controller.

3.6.3.2 PCH-IO Configuration

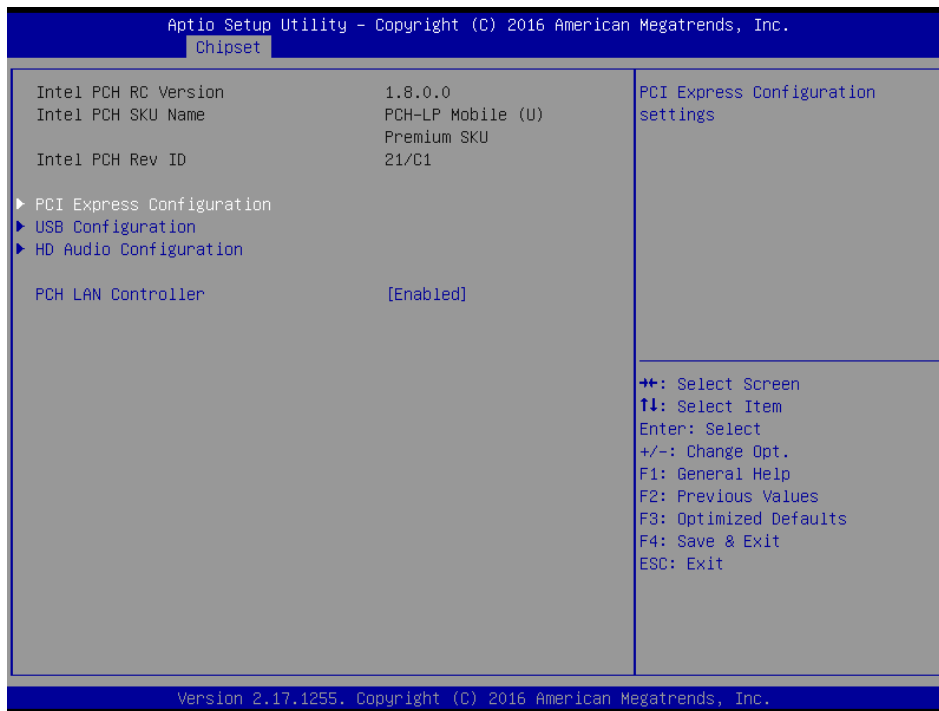

Item	Option	Description
PCH LAN Controller	Disabled Enabled[Default]	Enable or disable onboard NIC.

3.6.3.2.1 PCI Express Configuration



3.6.3.2.1.1 PCI Express Root Port5 (i210/211)

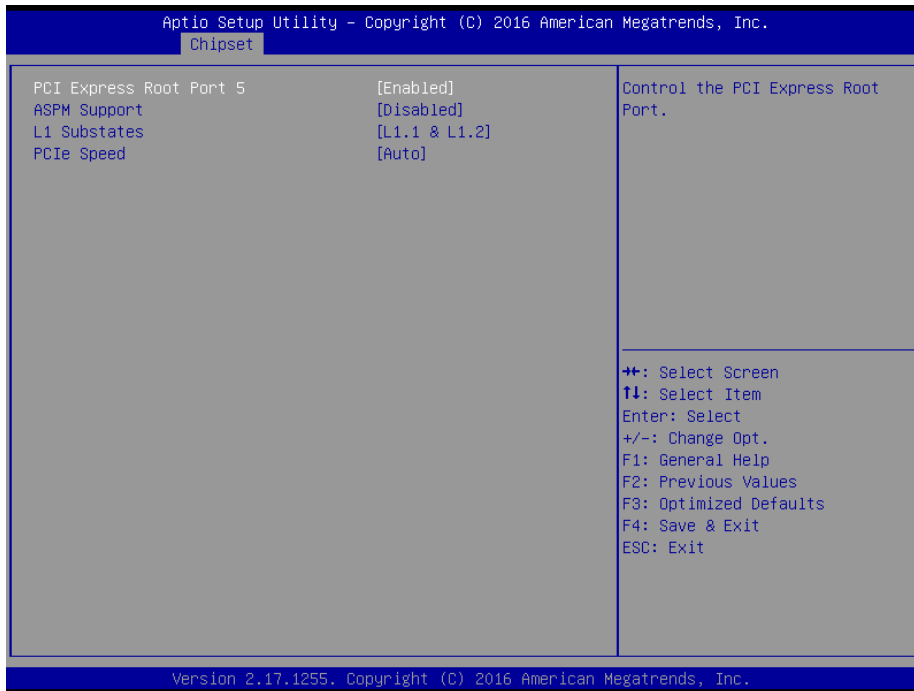

Item	Option	Description
PCI Express Root Port 5	Enabled[Default], Disabled	Control the PCI Express Root Port.
ASPM Support	Disabled [Default], L0s L1 L0sL1 Auto	Set the ASPM Level: Force L0s – Force all links to L0s State AUTO – BIOS auto configure DISABLE – Disables ASPM.
L1 Substates	Disabled L1.1 L1.2 L1.1 & L1.2[Default],	PCI Express L1 Substates settings.
PCIe Speed	Auto[Default] Gen1 Gen2 Gen3	Select PCI Express port speed.

3.6.3.2.1.2 PCI Express Root Port8 (B2B mPCIe)

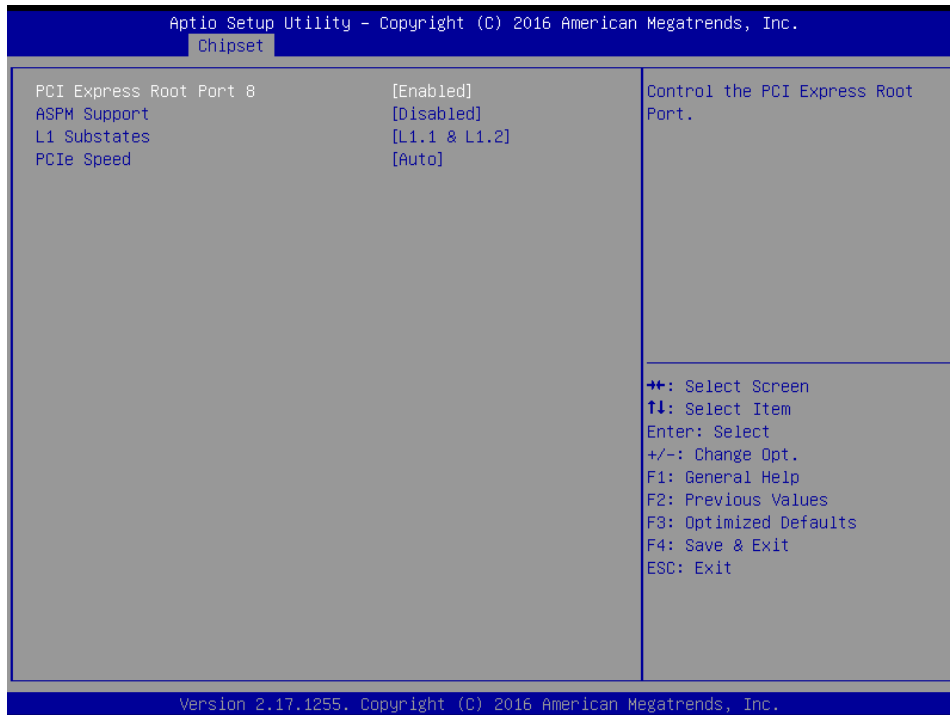

Item	Option	Description
PCI Express Root Port 8	Enabled[Default], Disabled	Control the PCI Express Root Port.
ASPM Support	Disabled [Default], L0s L1 L0sL1 Auto	Set the ASPM Level: Force L0s – Force all links to L0s State AUTO – BIOS auto configure DISABLE – Disables ASPM.
L1 Substates	Disabled L1.1 L1.2 L1.1 & L1.2[Default],	PCI Express L1 Substates settings.
PCIe Speed	Auto[Default] Gen1 Gen2 Gen3	Select PCI Express port speed.

3.6.3.2.1.3 PCI Express Root Port12 (mPCIe)

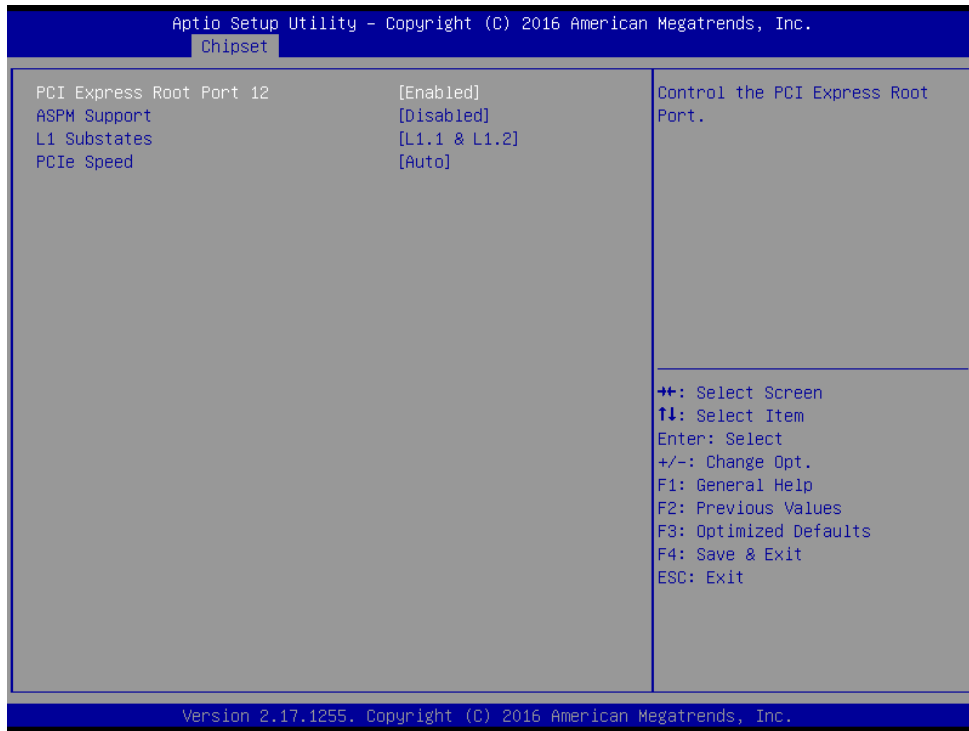

Item	Option	Description
PCI Express Root Port 12	Enabled[Default], Disabled	Control the PCI Express Root Port.
ASPM Support	Disabled [Default], L0s L1 L0sL1 Auto	Set the ASPM Level: Force L0s – Force all links to L0s State AUTO – BIOS auto configure DISABLE – Disables ASPM.
L1 Substates	Disabled L1.1 L1.2 L1.1 & L1.2[Default],	PCI Express L1 Substates settings.
PCIe Speed	Auto[Default] Gen1 Gen2 Gen3	Select PCI Express port speed.

3.6.3.2.2 USB Configuration

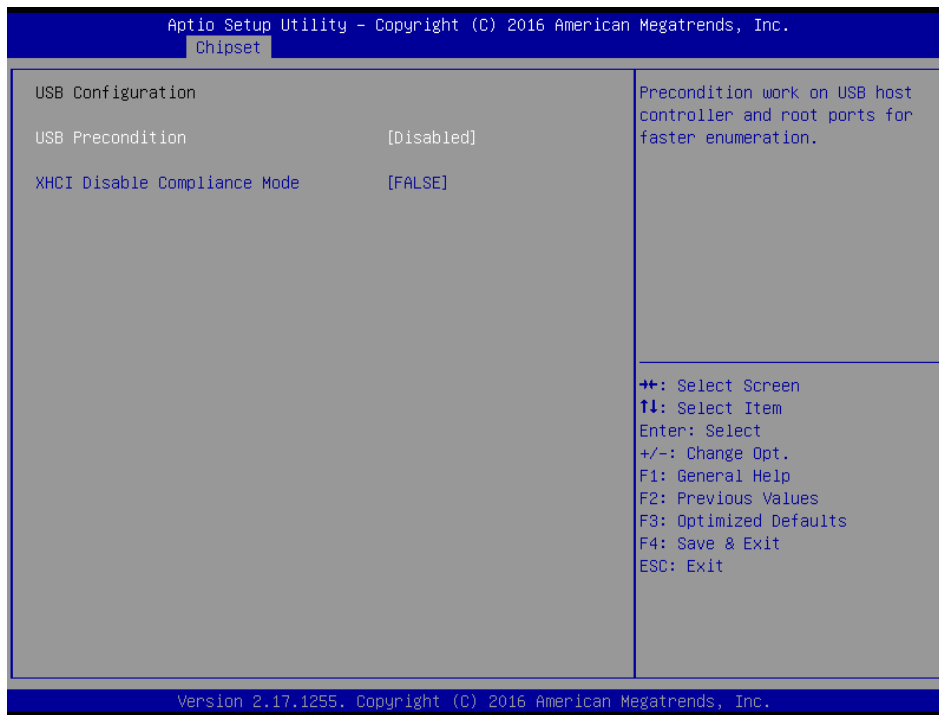

Item	Option	Description
USB Precondition	Enabled Disabled [Default] ,	Precondition work on USB host controller and root ports for faster enumeration.
XHCI Disable Compliance Mode	FALSE [Default] , TRUE	Option to disable Compliance Mode. Default is FALSE to not disable Compliance Mode. Set TRUE to disable Compliance Mode.

3.6.3.2.3 HD Audio Configuration

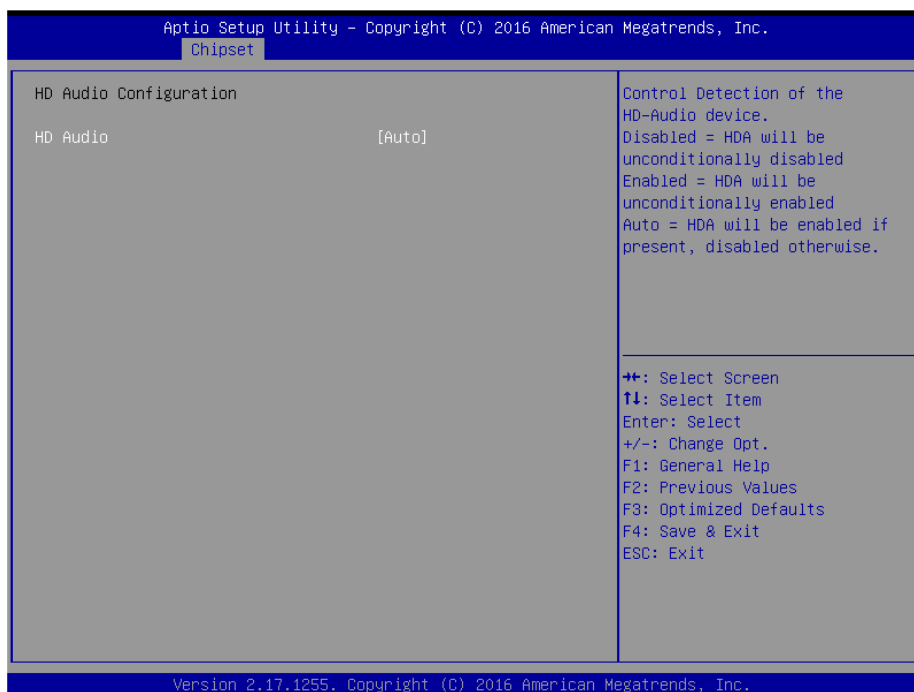

Item	Option	Description
HD Audio	Disabled Enabled Auto[Default],	Control Detection of the HD-Audio device. Disable = HDA will be unconditionally disabled Enabled = HDA will be unconditionally enabled Auto = HDA will be enabled if present, disabled otherwise.

3.6.4 Security

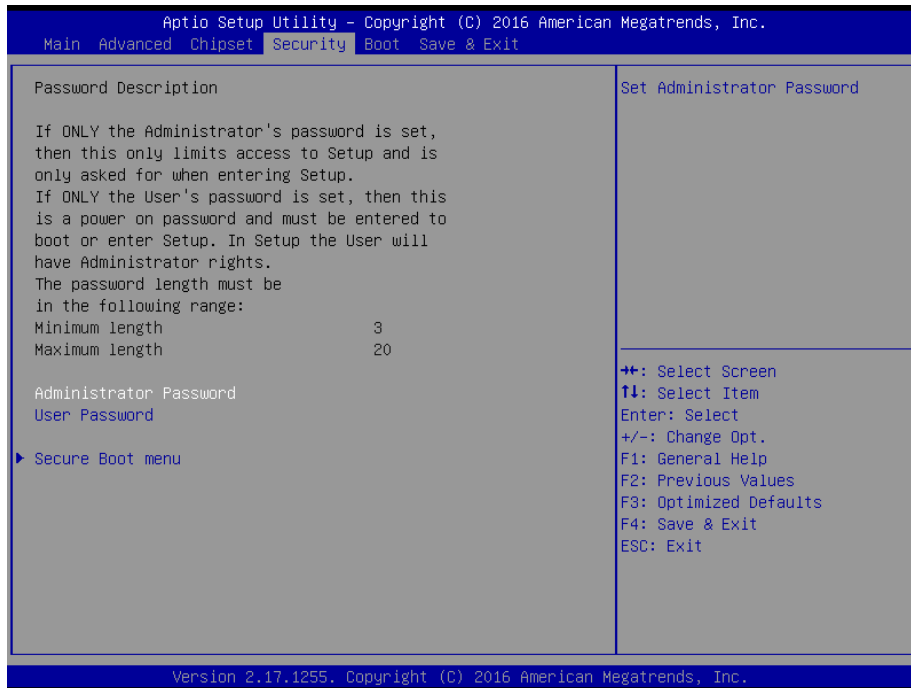

- **Administrator Password**

Set setup Administrator Password

- **User Password**

Set User Password

3.6.4.1 Secure Boot menu

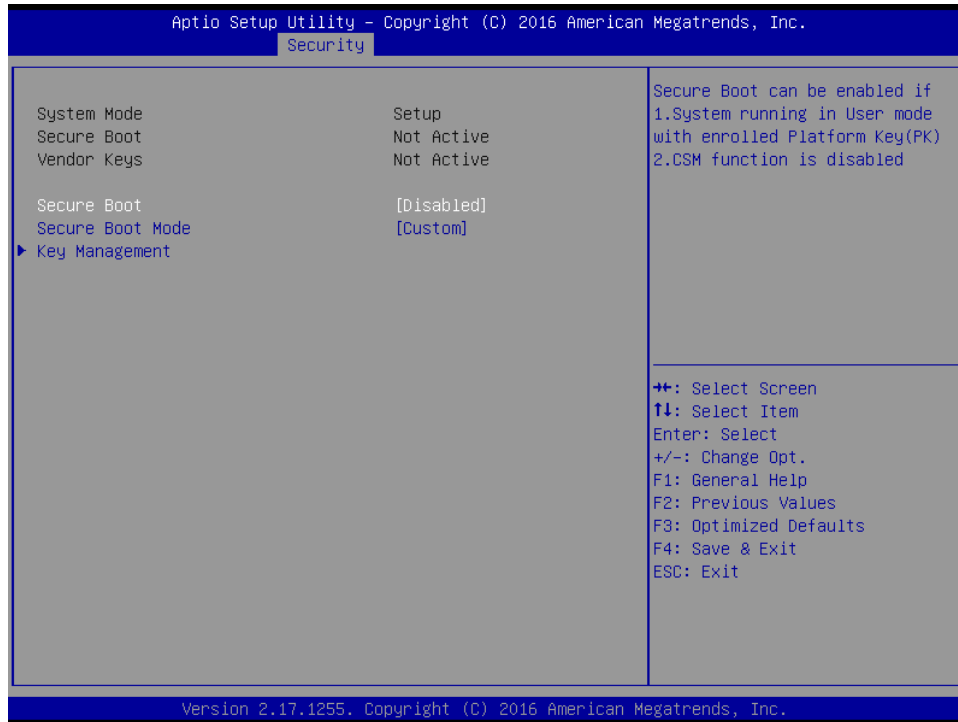

Item	Option	Description
Secure Boot	Disabled [Default] Enabled	Secure Boot can be enabled if 1.System running in User mode with enrolled Platform Key(PK) 2.CSM function is disabled.
Secure Boot Mode	Standard Custom [Default]	Secure Boot mode selector. 'Custom' Mode enables users to change Image Execution policy and manage Secure Boot Keys.

3.6.4.1.1 Key Management

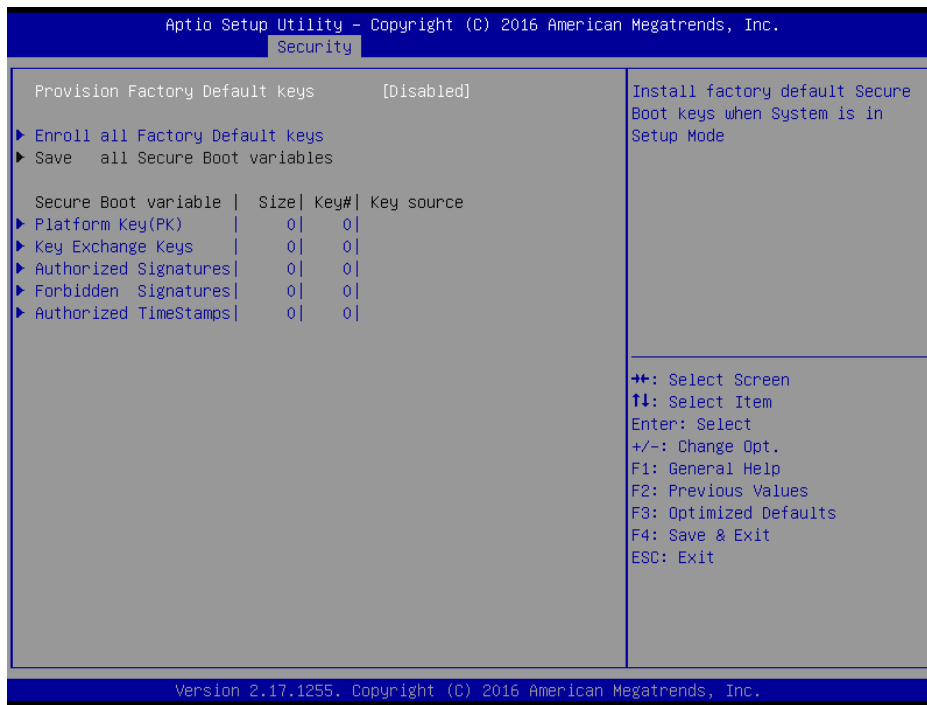

Item	Option	Description
Provision Factory Default keys	Enabled, Disabled[Default]	Install Factory default Secure Boot Keys when System is in Setup Mode.

3.6.5 Boot



Item	Option	Description
Setup Prompt Timeout	1~ 65535	Number of seconds to wait for setup activation key. 65535(0xFFFF) means indefinite waiting.
Bootup NumLock State	On[Default] Off	Select the Keyboard NumLock state
Quiet Boot	Disabled[Default] Enabled	Enables or disables Quiet Boot option
Fast Boot	Disabled[Default] Enabled	Enables or disables boot with initialization of a minimal set of devices required to launch active boot option. Has no effect for BBS boot options.
Boot Option #1	Set the system boot order.	

3.6.6 Save and exit

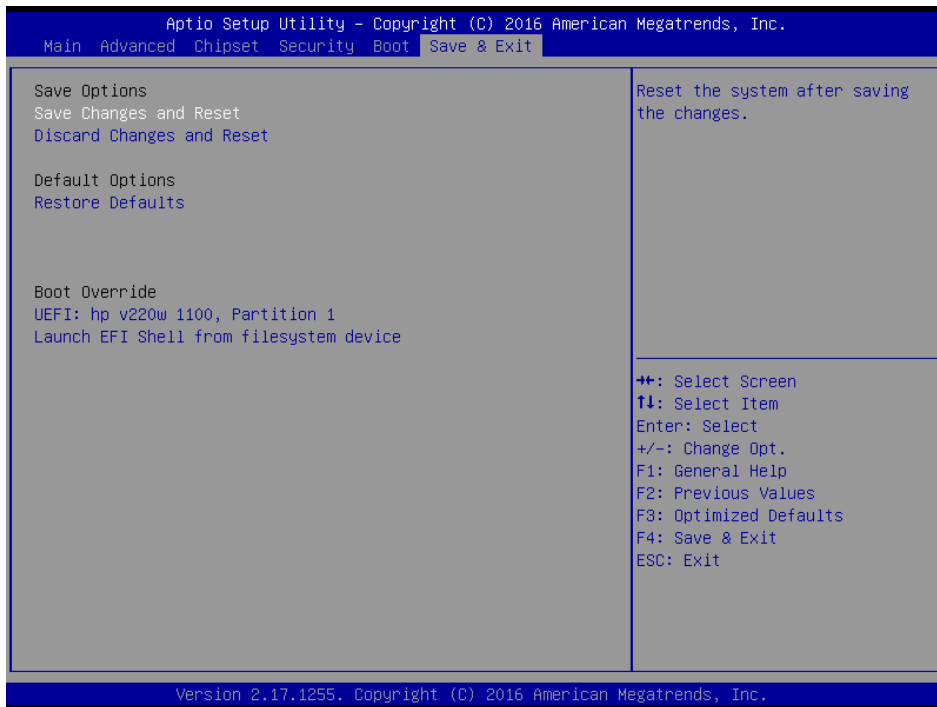

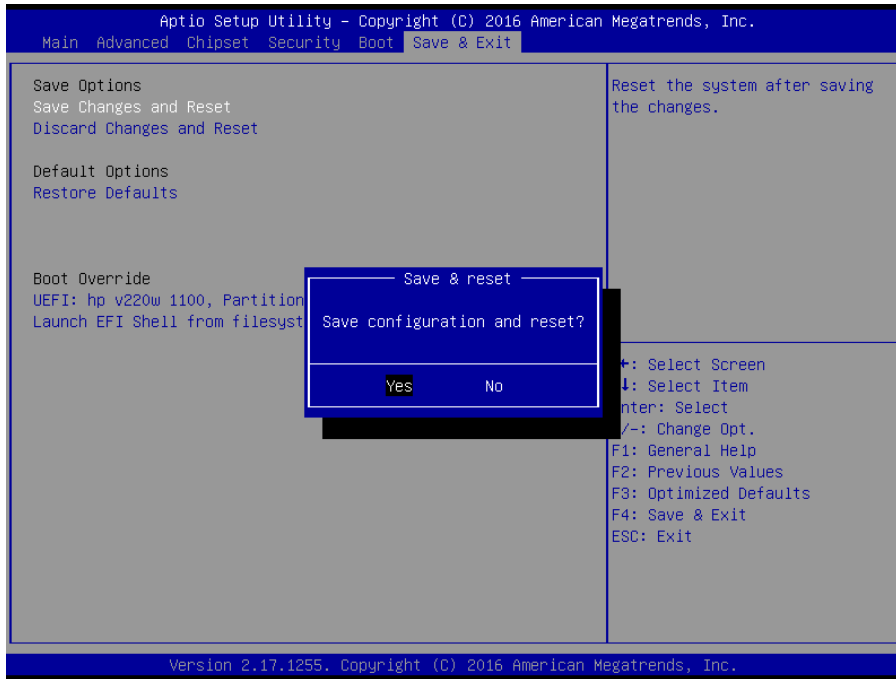

3.6.6.1 Save Changes and Reset

Reset the system after saving the changes.

3.6.6.2 Discard Changes and Reset

Any changes made to BIOS settings during this session of the BIOS setup program are discarded. The setup program then exits and reboots the controller.

3.6.6.3 Restore Defaults

This option restores all BIOS settings to the factory default. This option is useful if the controller exhibits unpredictable behavior due to an incorrect or inappropriate BIOS setting.

3.6.6.4 Launch EFI Shell from filesystem device

Attempts to Launch EFI Shell application (Shellx64.efi) from one of the available filesystem devices.

